

Instruction Sheet

SC-600

CAT. NO. 71197000

AMPLIFIED BROADBAND UHF
ANTENNA SPLITTER-COMBINER

PN 801547-1

General Description

The SC-600 Amplified Broadband Splitter-Combiner makes it possible to operate eight UHF wireless intercom transceivers using only two antennas.

It also features a high degree of output isolation; a necessity in multi-frequency systems to prevent intermodulation.

DO NOT attempt to install and/or turn on the power to the SC-600 until you have read completely and understood this manual.

SPECIFICATIONS

Frequency Range520-760 MHz
Antenna Connectors.....Standard TNC Receptacles
AC Power Input.....110\220 VAC 50\60Hz, 130 VA
DC Power Output:15 VDC 1.3A
Size (Approximate).....H: 3.50" (88.9mm), W: 17.00" (431.8mm) D: 12.50" (317.5mm)
Weight: (Approximate).....15 lbs.

Antenna Splitter

3rd Order Intercept Output:.....Greater than 28 dBm
Net Gain.....Greater than 2 dB
Noise FigureLess than 4 dB
Output IsolationGreater than 20 dB

Antenna Combiner

Net Gain.....0 dB
Noise Figure10 dB Typical
3rd Order Intermodulation-55 dbm @ + 13 dbm
Input, Each Transmitter

SC-600 Product Features:

- Ideal compliment to your BTR-600/BTR-500 UHF Wireless Intercom System
- Standard IEC 320 Power Input Connector
- Power Output for up to eight transceivers help make your whole system easier to handle
- High-quality TNC Connectors ensure consistent impedance across the entire frequency range
- Rack Mount Brackets included for 19" (482.6mm) rack

System Configuration

Figure 2 illustrates the typical system configuration using the SC-600.

SPECIAL NOTE: In any system, unused splitter outputs should be terminated with a 50 ohm “dummy load”. See the accessories listing at the end of this manual.

Power Supply

The SC-600 is equipped with an internal 110/220 VAC @ 50/60 Hz power supply that is rated with a minimum output of 15 VDC at 1.3 amps. A standard IEC320 power input connector is provided to reduce external wiring.

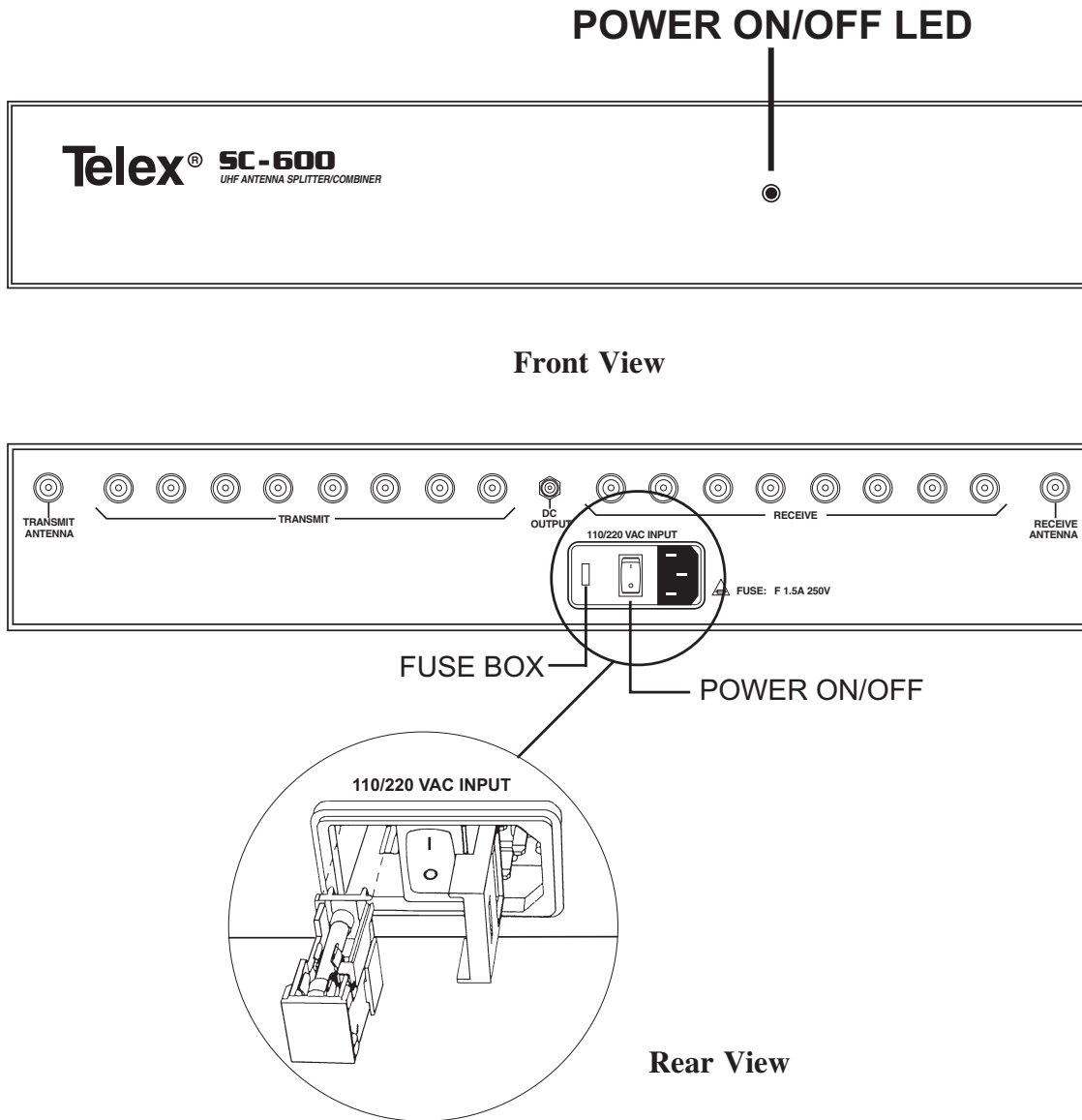

Figure 1
Front and Rear View

110/220 Volt Operation

Operation in either 110 VAC or 220 VAC is easily achieved. If the voltage indicated on the fuse box does not match the voltage you are operating in, the fuse must be changed. Open the fuse box door to remove and rotate the fuse holder. Make sure the voltage indicated, when the fuse box door is closed, matches your operation voltage. Refer to Figure 1.

**TRANSMIT
ANTENNA**

**RECEIVE
ANTENNA**

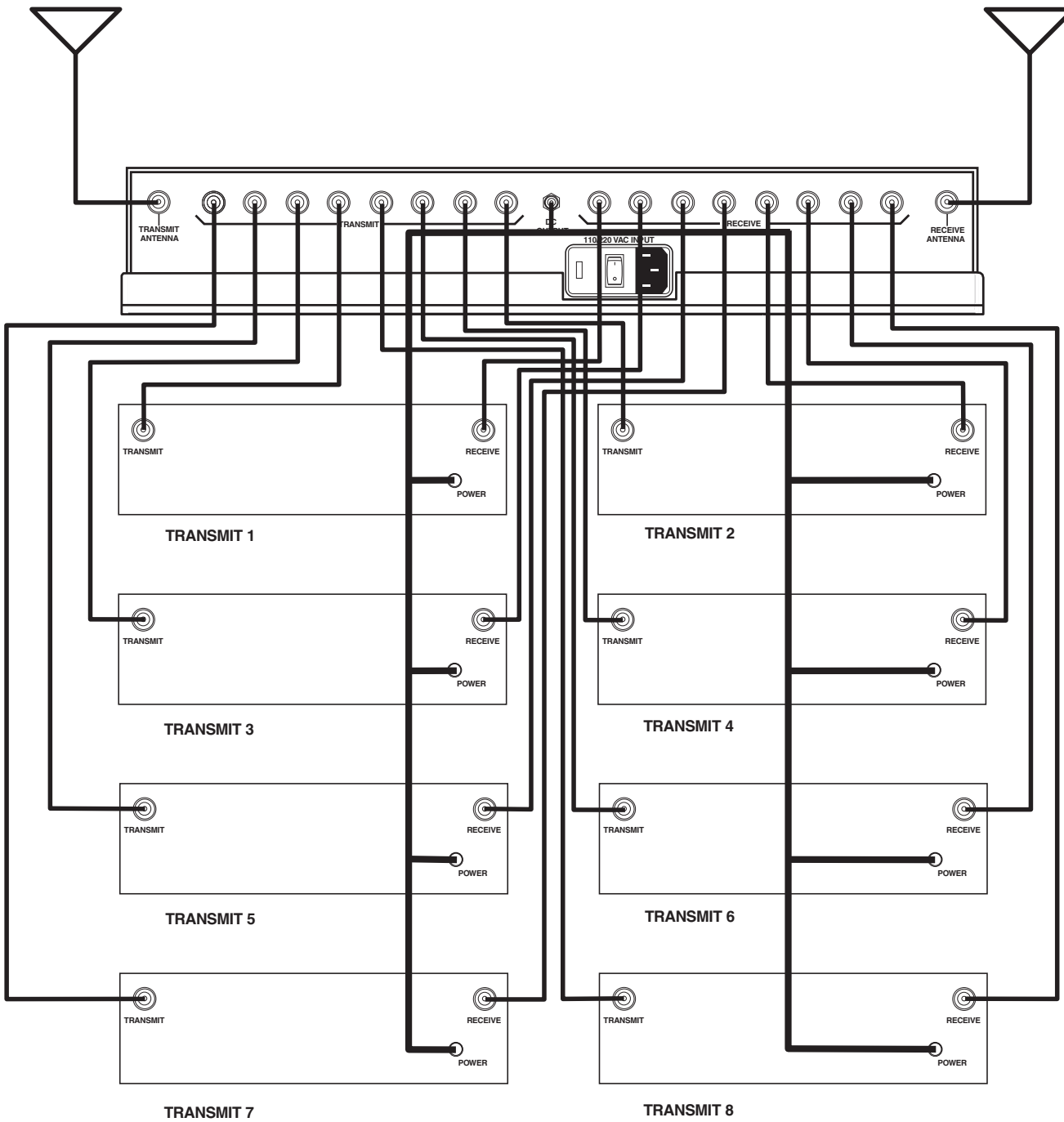

**Figure 2
System Configuration**

Antenna Requirements

The SC-600 may be used with a variety of antennas. For best results, use a pair of ALP-450 directional log periodic antennas (See Figure 3) or, the ALP-600 Bi-directional log periodic antenna (See Figure 4).

Good results may be obtained with 1/2 wave antennas (See Figure 5). All antennas are sold separately.

When using 1/2 wave antennas, we recommend using the higher frequency model when the receivers operate in more than one band. If the receivers are more than one band apart, such as yellow and white, we strongly recommend using the ALP-450, or ALP-600 depending on the application.

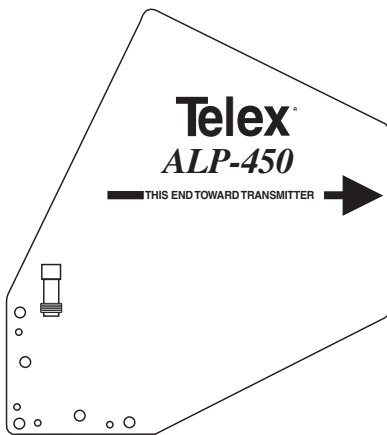

Figure 3
ALP-450

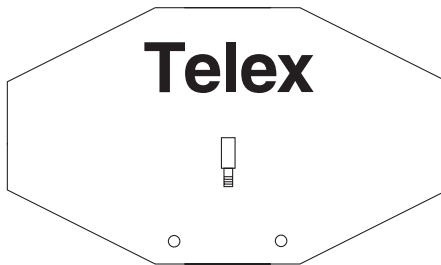

Figure 4
ALP-600

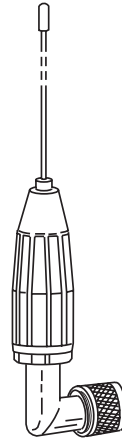

Figure 5
1/2 Wave Antenna

1/2 Wave Antenna Placement

If 1/2 wave antennas are mounted directly to the SC-600, they should be configured as shown in Figure 6.

Do not rack mount the SC-600 in this configuration. Serious loss of range and performance may occur.

Place the SC-600 with antennas in a location that is in direct view of the transmitters for best results.

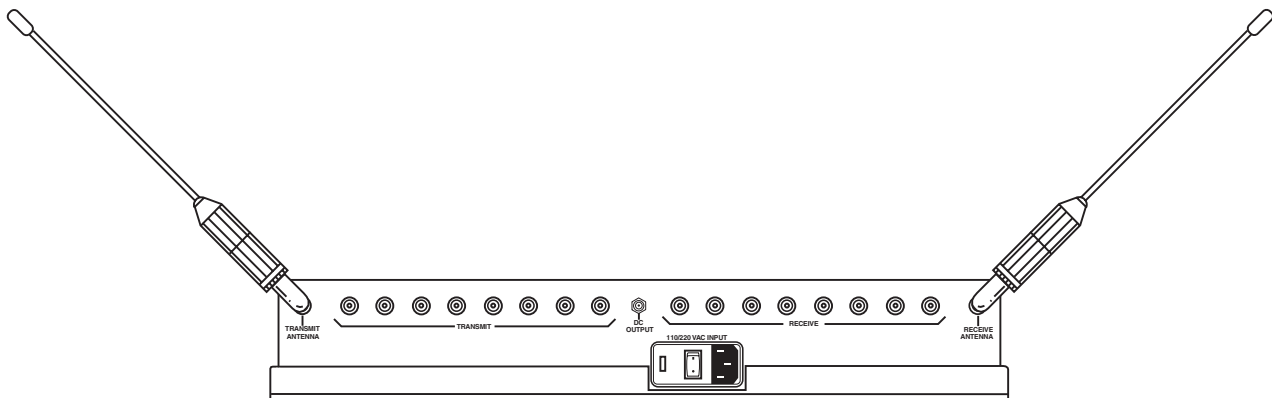

Figure 6
1/2 Wave Antenna Mounting

Antenna Placement for Optimum Range and Rack Mounting

For maximum range and when rack mounting, the antennas must be remotely located.

The ALP-450 and ALP-600 antennas come complete with a variety of mounting hardware and 10 feet (3 meters) of low loss coaxial cable. A combination mounting bracket with 10 feet of coaxial cable is available for the 1/2 wave antenna (Model No. AB-2).

Antennas should be placed in a location with a clear “signal path” to the transmitter. This “path” should be as short and free of obstructions as possible. Obstructions, such as walls ceilings, and metal objects, will reduce range and performance.

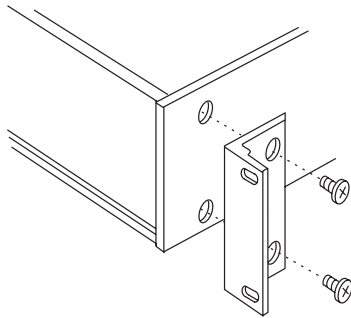

Figure 7
Rack Mounting

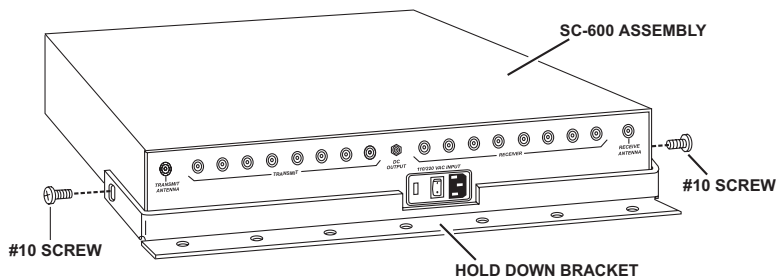

Figure 8
SC-600 Hold Down Bracket
Rear View

Rack Mounting

NOTE: The SC-600 should always be mounted on the bottom of the rack to fully support the chassis. Failure to do this may result in damage to the SC-600.

Rack mount and hold down brackets are supplied with the SC-600. To attach the brackets, proceed as follows:

- Align the rack mount bracket with the holes on the side of the unit. See Figure 7.
- Install flat head machine screws in two holes. Tighten securely. Repeat on the other side of the unit. For best alignment, perform the above steps while the unit and rack brackets are setting on a flat surface.
- Install the hold down bracket. Remove hex head machine screws located on SC-600 chassis on both sides in the rear part of side panels. Align mounting holes of hold down bracket to threaded holes for the screws. Insert screws and tighten until snug. Use appropriate fasteners to secure hold down bracket to desired mounting surface. See Figure 8.
- Insert the unit into a 19" rack enclosure and insert four #10-32 x 3/8" Phillips pan head screws (supplied) in each corner of the rack mount brackets and secure.

Coax Cable

For best results, it is recommended that cable losses be kept under 4 dB. (Every 3 dB of signal loss results in a system operating distance reduction of 25%.)

See the accessories section of this manual for special low loss cable assemblies.

SC-600 Accessories and Replacement Parts

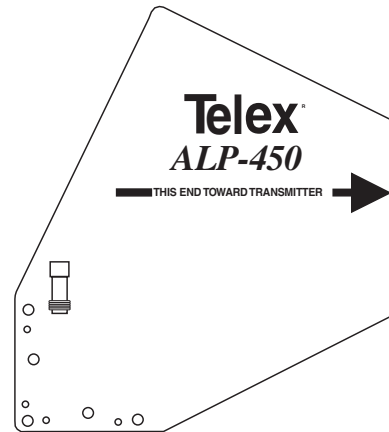
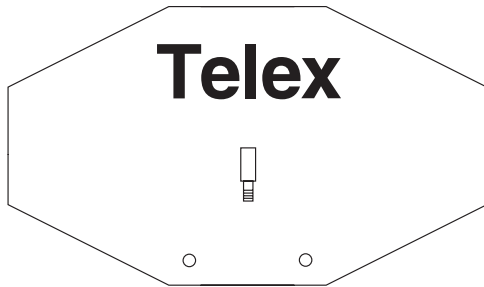

ALP-600

520-760 MHz Bi-Directional log periodic antenna
Includes mounting hardware and 10 feet (3 meter)
coaxial cable with TNC connectors

Order No. 878896

ALP-450

450-900 MHz Log Periodic Antenna
Includes mounting hardware and 10 feet (3 meter)
coaxial cable with TNC connectors

Order No. 71147000

Special low loss antenna cables with TNC connectors

Model	Length	Order No.
CXU-10	10 Ft. (3 meter)	690419
CXU-25	25 Ft. (7.6 meter)	71151-025
CXU-50	50 Ft. (15 meter)	71151-050
CXU-75	75 Ft. (23 meter)	71151-075
CXU-100	100 Ft.(30 meter)	71151-100

1/2 wave Antenna

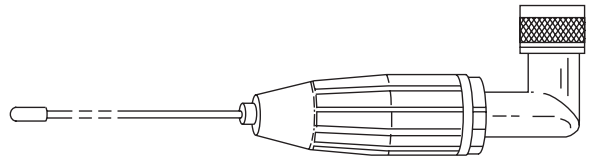

TP-2 50 OHM/TNC dummy load

(For unused outputs)

Part No. 650095

Model No.	Part No.	Band Color	Frequency
CLA-1	870658-1	Blue	520-564.9 MHz
CLA-2	870658-2	Yellow	565-614.9 MHz
CLA-3	870658-3	Red	615-659.9 MHz
CLA-4	870658-4	White	660-689.9 MHz
CLA-5	870658-5	Green	690-724.9 MHz
CLA-6	870658-6	Orange	725-760 MHz

IEC 320 Cordsets

Type	Part No.
230V 50 Hz (Euro)	58349008
230V 50 Hz (U.K.)	550024004
120V 60 Hz (U.S.)	8800102668

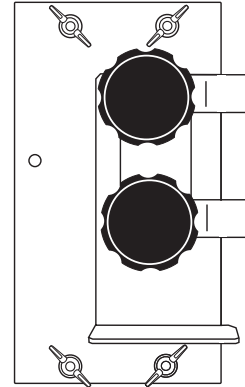
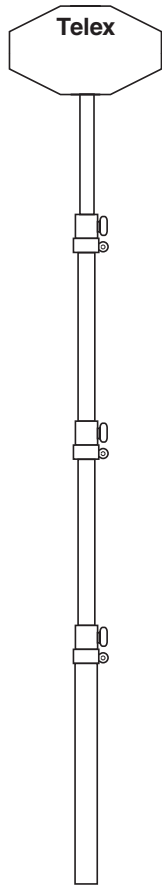

Antenna Bracket Kit
Aluminum Brackets with vertical or horizontal
mounting capability
Order No. 878898

Antenna Mast

Four section, clear anodized aluminum mast
with extended length of 90 1/4"

Order No. 878897-1

(Antenna not included)