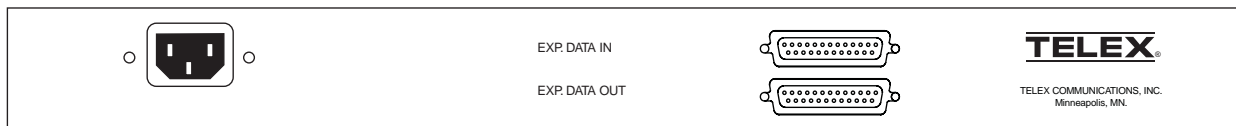
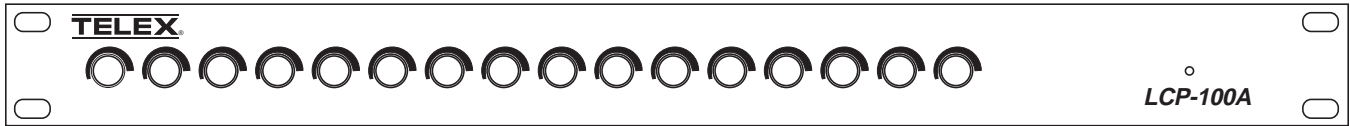


# USER INSTRUCTIONS

## MODEL LCP-100A LEVEL CONTROL PANEL FOR KP96/97/98 KEYPANELS WITH KP96-RC REAR CONNECTOR PANELS AND EKP96/97 EXPANSION PANELS WITH DUAL CONTROL CONNECTORS



### General Description

The LCP-100A Level Control Panel gives keypanel operators direct access to the crosspoint gain adjustment feature of the intercom system. It lets them adjust the individual listen levels for 16 keypanel or expansion panel keys.

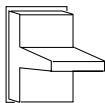
### Upgrade EEPROM

The LCP-100A is compatible with all KP96, KP97, and KP98-7 Keypanels. However, the supplied keypanel EEPROM may need to be installed in some cases. Since the EEPROM is different for each keypanel model, the LCP-100A is packaged under three different catalog numbers. See Table 1. The following paragraphs summarize the keypanel model and EEPROM version identification, and the procedure to replace the EEPROM. Note that the new EEPROM changes the keypanel DIP switch functions as summarized on page 2.

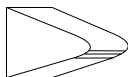
### Keypanel Model Identification

The KP98-7 Keypanel has all pushbutton keys. Identify KP96 and KP97 Keypanels by the talk key style.

KP96 Keypanels (Carling Lever Keys)



KP97 Keypanels (TMC Lever Keys)



### Keypanel EEPROM Version Identification

**Keypanels with programming keypad:** Tap key sequence CLR-0-8. Then use the scroll up or down key to locate the version number. It will be something like V82 or V83G etc.

**Note:** If you are not able to determine the version with this key sequence, or if the keypanel does not have a programming keypad, replace the EEPROM.

**Table 1. LCP-100A catalog numbers and usage**

Catalog Number (On Box)	Usage
9000-7616-100	KP96 Keypanel. Install new keypanel EEPROM if current keypanel version is before 8.4G.
9000-7616-110	KP97 Keypanel. Install new keypanel EEPROM if current keypanel version is before 8.4G.
9000-7616-120	KP98-7 Keypanel. Install new keypanel EEPROM if current keypanel version is before 8.3.

## EEPROM Replacement

Use normal precautions when handling static-sensitive devices.

1. Unplug the keypanel power cord.
2. Remove the screws from the top cover.
3. Locate the old EEPROM (U305). Observe the orientation of the old EEPROM, then remove it and install the new EEPROM in the same orientation.
4. Replace the top cover and reconnect power.

### KP96/97 Keypanel DIP Switch Functions after EEPROM Replacement

Refer to Table 2 and the following descriptions.

**Important:** Any time you change the DIP switch settings you must turn the power off-then-on to reset.

#### Combinations of Expansion and Level Control Panels:

Dip switches 1 and 2 select the various allowable combinations of expansion panels and level control panels that can be connected to the keypanel.

**Winking On / Off:** DIP switch 3 turns the winking feature on or off. When winking is on, the LED in each listen key will wink when the talk key directly beneath it is on. This provides a visual reminder of any active talk paths. For some people, this may be distracting and the feature may be turned off.

**Keypanel Address:** DIP switches 4-7 set the keypanel address as before. See Table 4 for address numbers.

**Keypanel Baud Rate:** Dip switch 8 sets the baud rate as before.

### KP98-7 Keypanel DIP Switch Functions after EEPROM Replacement

Refer to Table 3 and the following descriptions.

**Important:** Any time you change the DIP switch settings you must turn the power off-then-on to reset.

**Talk Key Row Selection:** You can select whether you want the talk keys to use the top row (above the displays) or the bottom row. See DIP switch 1 settings.

**Table 2. KP96/97 DIP Switch Summary**

DIP Switch	Description	Settings (X=Don't care)				
		Combinations	SW 1	SW 2		
1, 2	Combinations of expansion and level control panels	0 EKP's, 0 or 1 LCP	X	Open		
		1 EKP, 0 to 2 LCP's	Open	Close		
		2 EKP's, 0 to 3 LCP's	Close	Close		
3	Winking On / Off	Open: Winking off Closed: Winking on				
		Address	SW 4	SW 5	SW 6	SW 7
4-7	Logical keypanel address select.	1	Close	Open	Open	Open
		2	Open	Close	Open	Open
		3	Close	Close	Open	Open
		4	Open	Open	Close	Open
		5	Close	Open	Close	Open
		6	Open	Close	Close	Open
		7	Close	Close	Close	Open
		8	Open	Open	Open	Close
8	Baud rate select	Open: 9600 baud Closed: 76.8 kbaud (DO NOT USE!)				

**Table 3. KP98-7 DIP Switch Summary**

DIP Switch	Description	Settings				
1	Talk key row select	Open: Use bottom row Closed: Use top row				
2	Expansion Panel In-use Indication	Open: Flash Closed: No flash				
3	LCP select	Open: No LCP connected Closed: LCP connected				
		Address	Sw 4	Sw 5	Sw 6	Sw 7
4-7	Logical keypanel address select.	1	Close	Open	Open	Open
		2	Open	Close	Open	Open
		3	Close	Close	Open	Open
		4	Open	Open	Close	Open
		5	Close	Open	Close	Open
		6	Open	Close	Close	Open
		7	Close	Close	Close	Open
		8	Open	Open	Open	Close
8	Baud rate select	Open: 9600 baud Closed: 76.8 kbaud (DO NOT USE!)				

### **Expansion Panel In-use Indication for IFB and ISO:**

The KP98-7 provides a flashing display indication when an IFB or ISO is in-use by another keypanel. Generally, the keypanel operator can distinguish this from an incoming call for two reasons: first, the flashing indication is slower than an incoming call indication; second, an IFB or ISO will generally have a distinctive name, and since calls are not normally received from an IFB or ISO, the keypanel operator is able to conclude that the flashing indication is not an incoming call.

EKP98-0 expansion panels connected to the KP98-7 are a different matter, however, since they use illuminated buttons without alphanumeric displays and cannot display names. In this case the keypanel operator can only distinguish between an in-use indication and an incoming call indication by the speed of the button flash. If this creates confusion, disable the flashing in-use indication by setting DIP switch 2 to the “closed” position.

**LCP Selection:** If a level control panel will be connected for use with the KP98-7, set DIP switch 3 to the “Closed” position. Otherwise, leave this switch in the “Open” position.

**Keypanel Address:** DIP switches 4-7 set the keypanel address as before. See Table 4 for address numbers.

**Baud Rate:** SW1-8 selects the baud rate as before.

## **Mounting**

For ease of use, we recommend mounting each LCP-100A directly above or below the keypanel or expansion panel that it will be used with. The LCP-100A knobs do line up with the keys on KP96/97 Keypanels and EKP96/97 Expansion Panels. When using the LCP-100A with a KP98-7, you may wish to label the knobs.

## **Connections**

### **KP96/97 Keypanels**

Typical connections for a KP97/96 keypanel are shown in Figure 1. A maximum of two expansion panels and three level control panels may be connected.

### **KP98-7 Keypanel**

Typical connections for the KP98-7 are shown in Figure 2. A maximum of one EKP98-0 and one LCP-100A may be connected. The LCP-100A can only be used to adjust levels for the KP98-7.

## **Operation Notes**

### **KP96/97 Keypanels**

Keypanel operation is described in the KP96/97 Operating Instructions Manual. Note that the MVOL feature is no longer applicable with the updated firmware. To adjust the listen level for any keypanel key, rotate the corresponding control on the LCP-100A.

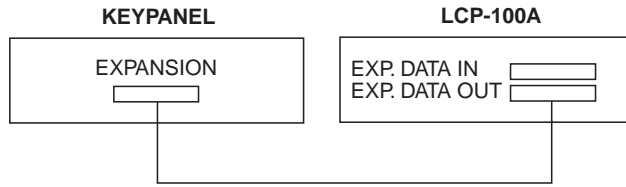
### **KP98-7 Keypanel**

Keypanel operation is described in the KP98-7 Operating Instructions Manual. Note that the MVOL feature is no longer applicable with the updated firmware. To adjust the listen level for any keypanel key, rotate the corresponding control on the LCP-100A.

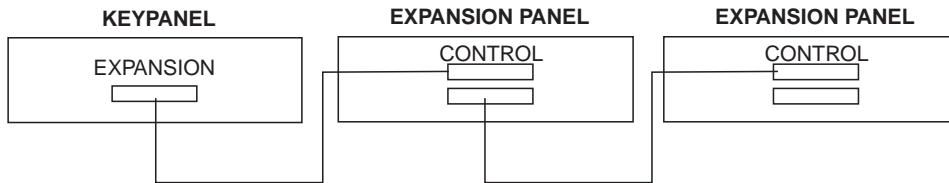
The EKP98-0 does not have listen keys, but only has talk keys. Therefore, it is not possible to manually activate the listen path corresponding to any talk key. Consequently, you should assign either the auto-listen or auto-reciprocal special function to all listen keys. Auto-listen will force the listen path to activate whenever the corresponding talk key is pressed. Auto-reciprocal will force the listen path to always be on.

Once you have assigned the EKP98-0 keys, you can adjust the listen levels using the crosspoint gain feature of ADAMedit (or ZEUSedit).

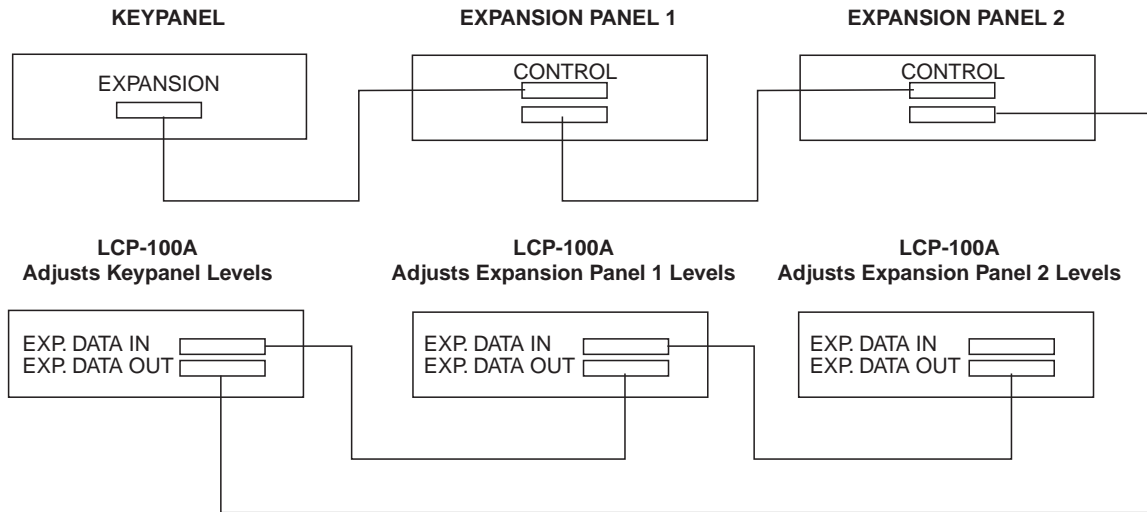
**Keypanel with LCP-100A Level Control Panel Only**



**Keypanel with Expansion Panels only. Note: Do not exceed 2 expansion panels.**

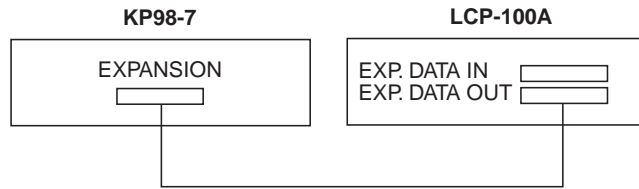


**Keypanel with Expansion Panels and LCP-100A Level Control Panels. Always connect the Level Control Panels after the Expansion Panels. Note: Do not exceed 2 expansion panels and 3 level control panels.**

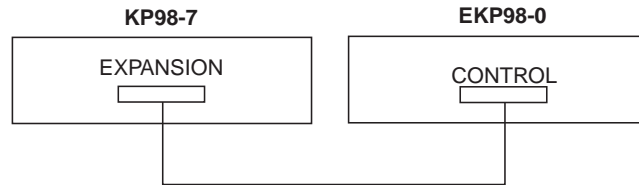


**Figure 1. Typical Interconnections when using a KP96/97 Keypanel. A maximum of two expansion panels and three level control panels may be connected.**

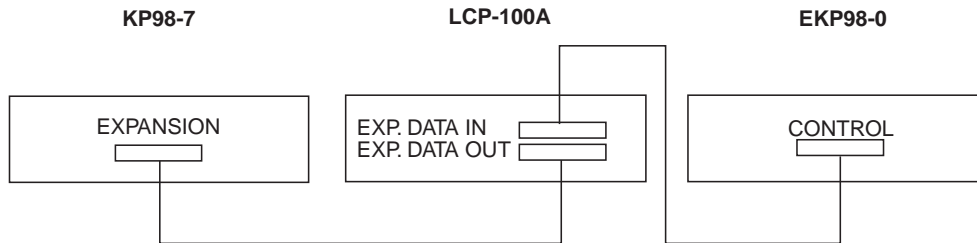
**KP98-7 Keypanel with LCP-100A Level Control Panel Only**



**KP98-7 Keypanel with EKP98-0 Expansion Panel Only**



**KP98-7 Keypanel with LCP-100A Level Control Panel and EKP98-0 Expansion Panel  
(The LCP-100A adjusts levels only for the KP98-7 Keypanel.)**



**Figure 2. Typical Interconnections when using a KP98-7 Keypanel. A maximum of one EKP98-0 and one LCP-100A may be connected. The LCP-100A can only be used to adjust levels for the KP98-7.**

**Table 4. Address Numbers for Intercom Ports**

Address Numbers	Intercom Port Numbers																								
	1	9	17	25	33	41	49	57	65	73	81	89	97	105	113	121	129	137	145	153	161	169	177	185	193
1	1	9	17	25	33	41	49	57	65	73	81	89	97	105	113	121	129	137	145	153	161	169	177	185	193
2	2	10	18	26	34	42	50	58	66	74	82	90	98	106	114	122	130	138	146	154	162	170	178	186	194
3	3	11	19	27	35	43	51	59	67	75	83	91	99	107	115	123	131	139	147	155	163	171	179	187	195
4	4	12	20	28	36	44	52	60	68	76	84	92	100	108	116	124	132	140	148	156	164	172	180	188	196
5	5	13	21	29	37	45	53	61	69	77	85	93	101	109	117	125	133	141	149	157	165	173	181	189	197
6	6	14	22	30	38	46	54	62	70	78	86	94	102	110	118	126	134	142	150	158	166	174	182	190	198
7	7	15	23	31	39	47	55	63	71	79	87	95	103	111	119	127	135	143	151	159	167	175	183	191	199
8	8	16	24	32	40	48	56	64	72	80	88	96	104	112	120	128	136	144	152	160	168	176	184	192	200
1	201	209	217	225	233	241	249	257	265	273	281	289	297	305	313	321	329	337	345	353	361	369	377	385	393
2	202	210	218	226	234	242	250	258	266	274	282	290	298	306	314	322	330	338	346	354	362	370	378	386	394
3	203	211	219	227	235	243	251	259	267	275	283	291	299	307	315	323	331	339	347	355	363	371	379	387	395
4	204	212	220	228	236	244	252	260	268	276	284	292	300	308	316	324	332	340	348	356	364	372	380	388	396
5	205	213	221	229	237	245	253	261	269	277	285	293	301	309	317	325	333	341	349	357	365	373	381	389	397
6	206	214	222	230	238	246	254	262	270	278	286	294	302	310	318	326	334	342	350	358	366	374	382	390	398
7	207	215	223	231	239	247	255	263	271	279	287	295	303	311	319	327	335	343	351	359	367	375	383	391	399
8	208	216	224	232	240	248	256	264	272	280	288	296	304	312	320	328	336	344	352	360	368	376	384	392	400
1	401	409	417	425	433	441	449	457	465	473	481	489	497	505	513	521	529	537	545	553	561	569	577	585	593
2	402	410	418	426	434	442	450	458	466	474	482	490	498	506	514	522	530	538	546	554	562	570	578	586	594
3	403	411	419	427	435	443	451	459	467	475	483	491	499	507	515	523	531	539	547	555	563	571	579	587	595
4	404	412	420	428	436	444	452	460	468	476	484	492	500	508	516	524	532	540	548	556	564	572	580	588	596
5	405	413	421	429	437	445	453	461	469	477	485	493	501	509	517	525	533	541	549	557	565	573	581	589	597
6	406	414	422	430	438	446	454	462	470	478	486	494	502	510	518	526	534	542	550	558	566	574	582	590	598
7	407	415	423	431	439	447	455	463	471	479	487	495	503	511	519	527	535	543	551	559	567	575	583	591	599
8	408	416	424	432	440	448	456	464	472	480	488	496	504	512	520	528	536	544	552	560	568	576	584	592	600
1	601	609	617	625	633	641	649	657	665	673	681	689	697	705	713	721	729	737	745	753	761	769	777	785	793
2	602	610	618	626	634	642	650	658	666	674	682	690	698	706	714	722	730	738	746	754	762	770	778	786	794
3	603	611	619	627	635	643	651	659	667	675	683	691	699	707	715	723	731	739	747	755	763	771	779	787	795
4	604	612	620	628	636	644	652	660	668	676	684	692	700	708	716	724	732	740	748	756	764	772	780	788	796
5	605	613	621	629	637	645	653	661	669	677	685	693	701	709	717	725	733	741	749	757	765	773	781	789	797
6	606	614	622	630	638	646	654	662	670	678	686	694	702	710	718	726	734	742	750	758	766	774	782	790	798
7	607	615	623	631	639	647	655	663	671	679	687	695	703	711	719	727	735	743	751	759	767	775	783	791	799
8	608	616	624	632	640	648	656	664	672	680	688	696	704	712	720	728	736	744	752	760	768	776	784	792	800