

# *MS-2002*

## *Master Station and Power Supply*

### *User Manual*



**PROPRIETARY NOTICE**

The product information and design disclosed herein were originated by and are the property of Bosch Security Systems, Inc. Bosch reserves all patent, proprietary design, manufacturing, reproduction, use and sales rights thereto, and to any article disclosed therein, except to the extent rights are expressly granted to others.

**COPYRIGHT NOTICE**

Copyright 2010 by Bosch Security Systems, Inc. All rights reserved. Reproduction, in whole or in part, without prior written permission from Bosch is prohibited.

**WARRANTY NOTICE**

See the enclosed warranty card for further details.

**CUSTOMER SUPPORT**

Technical questions should be directed to:

Customer Service Department  
 Bosch Security Systems, Inc.  
 12000 Portland Avenue South  
 Burnsville, MN 55337 USA  
 Telephone: 800-392-3497  
 Fax: 800-323-0498  
 Factory Service: 800-553-5992 (Lincoln, NE)

**RETURN SHIPPING INSTRUCTIONS**

Customer Service Department  
 Bosch Security Systems, Inc. (Lincoln, NE)  
 Telephone: 402-467-5321  
 Fax: 402-467-3279  
 Factory Service: 800-553-5992

Please include a note in the box which supplies the company name, address, phone number, a person to contact regarding the repair, the type and quantity of equipment, a description of the problem and the serial number(s).




**SHIPPING TO THE MANUFACTURER**

All shipments of product should be made via UPS Ground, prepaid (you may request from Factory Service a different shipment method). Any shipment upgrades will be paid by the customer. The equipment should be shipped in the original packing carton. If the original carton is not available, use any suitable container that is rigid and of adequate size. If a substitute container is used, the equipment should be wrapped in paper and surrounded with at least four (4) inches of excelsior or similar shock-absorbing material. All shipments must be sent to the following address and must include the Proof of Purchase for warranty repair. Upon completion of any repair the equipment will be returned via United Parcel Service or specified shipper, collect.

Factory Service Department  
 Bosch Security Systems, Inc.  
 8601 East Cornhusker Hwy.  
 Lincoln, NE 68507 U.S.A.  
 Attn: Service

This package should include the following:

QTY	DESCRIPTION	PART NUMBER
		90107749000 (US)
1	MS2002 Final Assembly	or
		90107749001 (EU)
1	User Information	38109-668
1	Statement of Conformity	38109-675
1	Warranty	38110-390
1	User Manual	9350-7749-000
1	1/1/4" Face Plate, Right, Black	91607353-003
1	1/1/4" Face Plate, Left, Black	91607353-002
1	Power Cord	25040003-00
1	Int'l Cordsets, European model only	550024000
2	Rack Mount Bracket	9110-7353-000

 THE LIGHTNING FLASH AND ARROWHEAD WITHIN THE TRIANGLE IS A WARNING SIGN ALERTING YOU OF "DANGEROUS VOLTAGE" INSIDE THE PRODUCT.	 CAUTION: TO REDUCE THE RISK OF ELECTRIC SHOCK, DO NOT REMOVE COVER. NO USER-SERVICABLE PARTS INSIDE. REFER SERVICING TO QUALIFIED SERVICE PERSONNEL.	 THE EXCLAMATION POINT WITHIN THE TRIANGLE IS A WARNING SIGN ALERTING YOU OF IMPORTANT INSTRUCTIONS ACCOMPANYING THE PRODUCT
SEE MARKING ON BOTTOM/BACK OF PRODUCT		


**WARNING:** APPARATUS SHALL NOT BE EXPOSED TO DRIPPING OR SPLASHING AND NO OBJECTS FILLED WITH LIQUIDS, SUCH AS VASES, SHALL BE PLACED ON THE APPARATUS.

**WARNING:** THE MAIN POWER PLUG MUST REMAIN READILY OPERABLE.

**CAUTION:** TO REDUCE THE RISK OF ELECTRIC SHOCK, GROUNDING OF THE CENTER PIN OF THIS PLUG MUST BE MAINTAINED.

**WARNING:** TO REDUCE THE RISK OF FIRE OR ELECTRIC SHOCK, DO NOT EXPOSE THIS APPRATUS TO RAIN OR MOISTURE.

**WARNING:** TO PREVENT INJURY, THIS APPARATUS MUST BE SECURELY ATTACHED TO THE FLOOR/WALL/RACK IN ACCORDANCE WITH THE INSTALLATION INSTRUCTIONS.

	This product is AC only.
---	--------------------------

## *Important Safety Instructions*

1. Read these instructions.
2. Keep these instructions.
3. Heed all warnings.
4. Follow all instructions.
5. Do not use this apparatus near water.
6. Clean only with dry cloth.
7. Do not block any ventilation openings. Install in accordance with the manufacturer's instructions.
8. Do not install near any heat sources such as radiators, heat registers, stoves, or other apparatus (including amplifiers) that produce heat.
9. Do not defeat the safety purpose of the polarized or grounding-type plug. A polarized plug has two blades with one wider than the other. A grounding type plug has two blades and a third grounding prong. The wide blade or the third prong are provided for your safety. If the provided plug does not fit into your outlet, consult an electrician for replacement of the obsolete outlet.
10. Protect the power cord from being walked on or pinched particularly at plugs, convenience receptacles, and the point where they exit from the apparatus.
11. Only use attachments/accessories specified by the manufacturer.
12. Use only with the cart, stand, tripod, bracket, or table specified by the manufacturer, or sold with the apparatus. When a cart is used, use caution when moving the cart/apparatus combination to avoid injury from tip-over.
13. Unplug this apparatus during lightning storms or when unused for long periods of time.
14. Refer all servicing to qualified service personnel. Servicing is required when the apparatus has been damaged in any way, such as power-supply cord or plug is damaged, liquid has been spilled or objects have fallen into the apparatus, the apparatus has been exposed to rain or moisture, does not operate normally, or has been dropped.



# Table of Contents

---

<b>INTRODUCTION</b> .....	7
Description .....	7
Features .....	8
<b>INSTALLATION</b> .....	9
Configuration Pre-check .....	9
Headset Microphone Type Selection DIP Switch .....	11
Mic Kill Send Enable DIP Switch .....	11
Program Interrupt DIP Switches .....	11
Incoming Call Beep DIP Switches .....	11
Monaural or Binaural Operation DIP Switches .....	12
Balanced Unbalance Switches .....	12
Direct Program Listen Enable / Disable Jumpers .....	12
Mounting .....	13
Connections .....	13
External Program Input and PA Output .....	13
Cables .....	14
<b>OPERATION AND SPECIFICATIONS</b> .....	9
Power-Up Check .....	9
Test Tone .....	9
Sidetone Adjustment .....	10
Voice-Activated Microphone (VOX) Setup .....	11
Operation .....	11
NORMAL VS. PROGRAMMING MODE .....	11
VOLUME ADJUSTMENT .....	12
RECEIVING CALLS .....	12
CALL AN INTERCOM CHANNEL .....	12
MICROPHONE MUTE DURING TALK .....	12
ALL TALK .....	13
Public Address .....	13
TURNING THE PROGRAM INPUTS ON AND OFF .....	13
Using Mic Kill .....	13
Using Voice-Activated Microphone (VOX) .....	14
Incoming Call Beep ON / OFF .....	14
Specifications .....	15
Quick Reference .....	17

---



*Introduction*

---

---

*Description*

The MS-2002 is a complete 2-channel master station and system power supply (24VDC, 2Amps total power) in a single unit. Simply plug it into any AC power outlet from 100 to 240 volts, add a microphone or headset, connect intercom stations to the back panel, and you're ready to communicate. It has both 1- and 2-channel connectors, so you do not have to add a separate breakout box if you want to mix 1- and 2-channel stations. The MS-2002 fits in a standard 19-inch equipment rack and is one (1) rack unit high. The basic MS-2002 can communicate with two (2) intercom channels. This number can be increased by connecting optional EMS-4001 Expansion Stations. Each EMS-4001 adds four (4) addition channels, and up to four (4) of these expansion stations can be connected for a total of 18 channels.

## Features

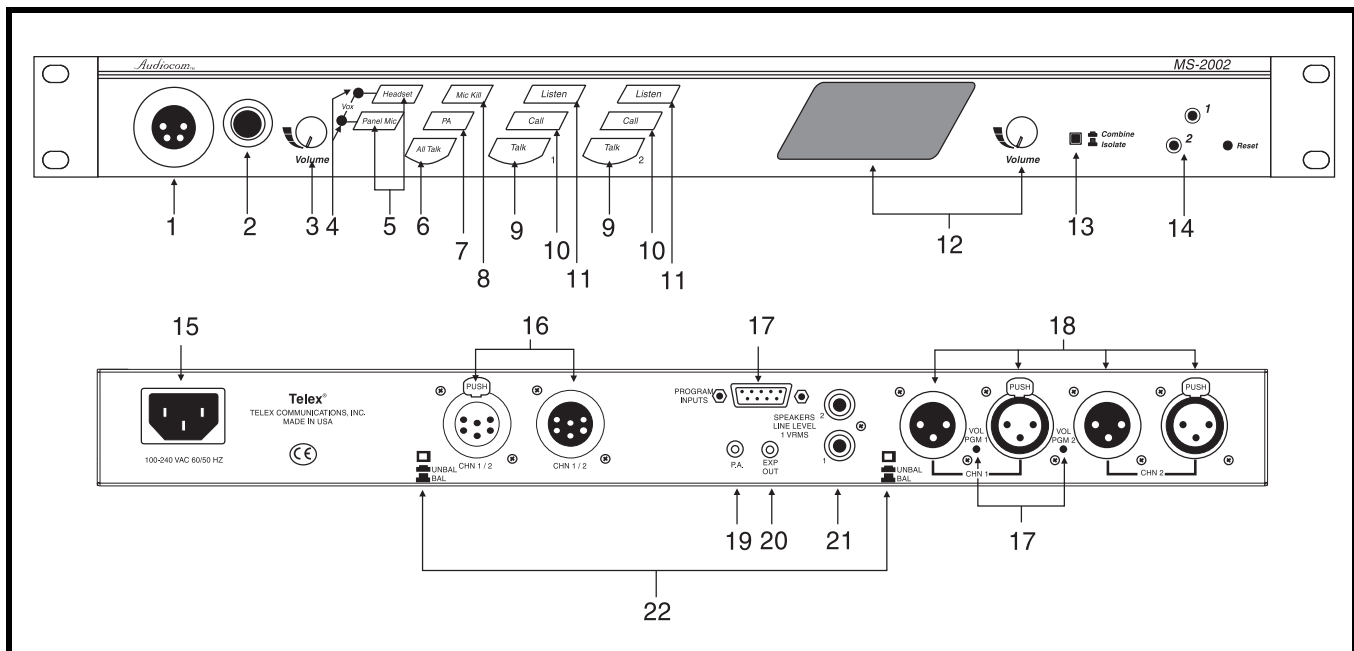


FIGURE 1. MS-2002 Reference View.

1. **Dynamic-Mic Headset Connector** - Accepts headsets with monaural headphones and either a balanced or unbalanced dynamic microphone.
2. **Panel Mic / Electret-Mic Headset Connector** - Accepts an electret gooseneck microphone, such as the Telex Model MCP-90-XX. The model MCP-90 series panel mic connector is a 1/4" stereo plug, with a threaded shaft for easy installation.
3. **Volume Control** - Adjusts headphone volume only.
4. **VOX Trimmers** - Used with the voice-activated microphone feature. Separate trimmers adjust the voice activation level for the headset and panel microphones.
5. **Headset and Panel Mic Keys** - Used to manually activate either the headset or panel microphone, whichever is being used.
6. **All Talk Key** - Used to talk to all stations that are listening on all channels. This includes both MS-2002 channels and all channels of any connected EMS-4001 Expansion Stations.
7. **PA Key** - If the MS-2002 is connected to a public address system, this key may be used to talk over the public address system.
8. **Mic Kill Key** - Used to turn off the microphones on any intercom stations on a channel. Also used to activate the program inputs and the audible beep feature for incoming calls.
9. **Intercom Talk Keys** - Momentary or latching (hands-free) operation possible.
10. **Call Keys** - Used to place calls on intercom channels and to indicate incoming calls.
11. **Intercom Listen Keys** - Momentary or latching operation possible.
12. **Speaker Volume Control** - The volume control adjusts the level to the front panel speaker. If an external speaker is used, volume must be adjusted at the external speaker.
13. **Combine / Isolate Switch** - This recessed, push-button switch lets you combine the audio signals of the two (2) channels to create a single audio channel where all users can intercommunicate. Or, you can isolate each channel to create two (2) groups of completely independent users. For normal operation, it should be set in the isolate position.
14. **Channel Status Indicators and Reset Push-buttons** - The indicators are green for normal operation and red when there is an overload or short circuit. The Reset push-button restores normal operation after the short-circuit or overload has been located and fixed.
15. **Universal AC Power Input** - The MS-2002 accepts any input power in the range of 100-240 VAD, 50/60 Hz.
16. **2-channel Intercom Cable Connectors** - One (1) male and one (1) female XLR-6 connector for 2-channel operation with SS2002, BP-2002, etc.
17. **Program Inputs Connector and Trimmers** - Each intercom channel has its own program input and level adjust trimmer. The program inputs may be turned on or off via the front panel and they may be set to interrupt during talk, if desired.
18. **1-channel Intercom Cable Connectors** - Two (2) connectors are provided for each channel for loop-through connection of 1-channel intercom stations, such as the SS-1002, BP-1002, etc.
19. **PA Output** - Connects to a public address system.
20. **Expansion Out Connector** - Connects to an EMS-4001 Expansion Station.
21. **Speaker Output Jacks** - May be used with external, powered loudspeakers for monaural or binaural listening configurations.
22. **Balanced / Unbalanced Selector Switches** - The selector switches sets the MS-2002 for compatibility with either Audiocom or Clear-Com channel connector pin-outs, channel power requirements, and call signaling requirements. Both switches must be in the same position.

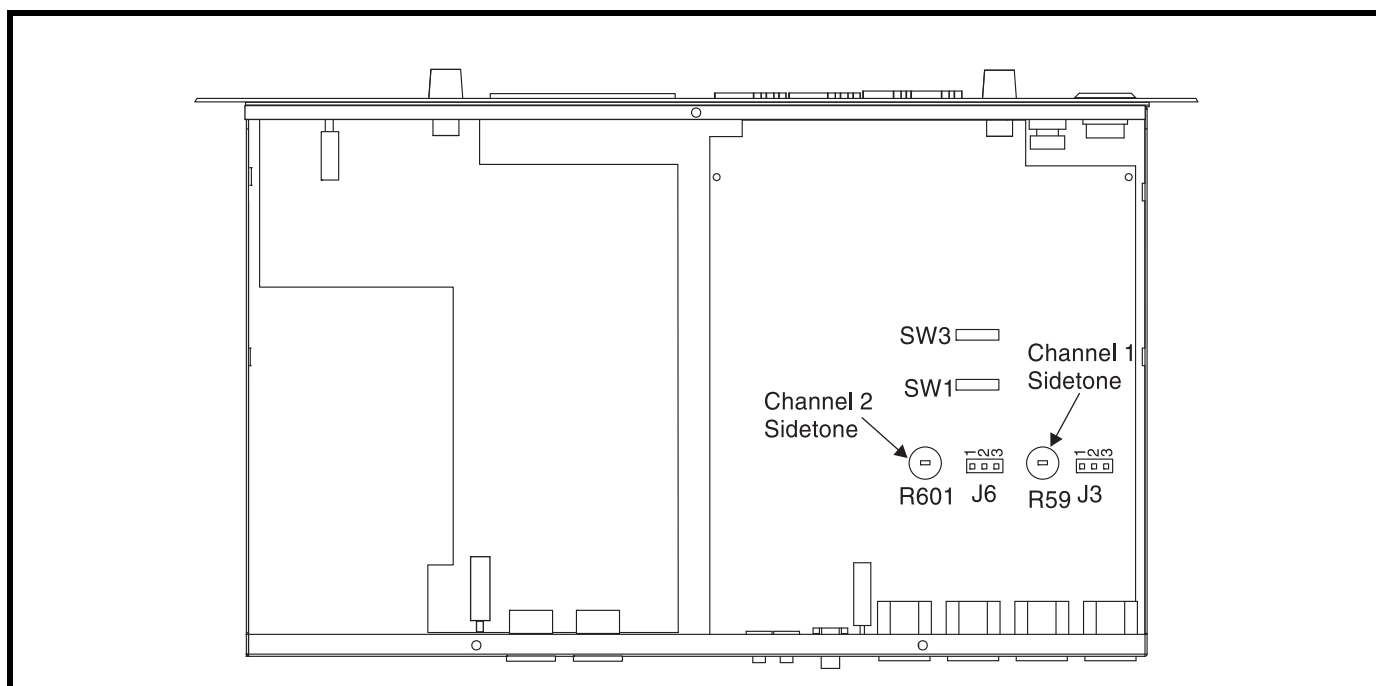


### *Configuration Pre-check*

Before connecting the MS-2002 make sure it is properly configured for you intended usage. The locations of the configuration switches are shown in Figure 2.

To **access internal switches**, do the following:

- > Remove **three (3) screws from the top cover** and **three (3) screws from the bottom portion** of each side.



**FIGURE 2.** Configuration Jumpers and Switches Location

Switch #	Description	Settings	Default
<b>DIP SWITCH SW1 (INTERNAL)</b>			
SW1-1	Headset Microphone Type	On: Unbalanced Off: Balanced	Off
SW1-2	Call Signal Send, channel 1	On: Enabled Off: Disabled	On
SW1-3	Call Signal Receive, channel 1	On: Enabled Off: Disabled	On
SW1-4	Call Signal Send, channel 2	On: Enabled Off: Disabled	On
SW1-5	Call Signal Receive, channel 2	On: Enabled Off: Disabled	On
SW1-6	Mic Kill Signal Send	On: Enabled Off: Disabled	Off
SW1-7	Program 2	On: Interrupt During Talk Off: No Interrupt	Off
SW1-8	Program 1	On: Interrupt During Talk Off: No Interrupt	Off
<b>BALANCED (BAL) - UNBALANCED (UNBAL) OPERATION</b> <b>BOTH SWITCHES MUST BE SET THE SAME</b> <b>FACTORY DEFAULT IS BALANCED</b>			
Rear Panel	Audiocom or Clear-Com operation	Out: Balanced (Audiocom) In: Unbalanced (Clear-Com)	Out (BAL)
Rear Panel	Audiocom or Clear-Com operation	Out: Balanced (Audiocom) In: Unbalanced (Clear-Com)	Out (BAL)
<b>DIP SWITCH SW3 (INTERNAL)</b> <b>*SET ALL TO MONAURAL OR ALL TO BINAURAL</b>			
SW3-1	Incoming Call Beep	On: Disabled Off: Enabled	Off
SW3-2*	Listen 1 to speaker 1 only	On: Enabled (Binaural) Off: Disabled (Monaural)	Off
SW3-3	Incoming Call Beep, Speaker 1	On: Enabled (SW3-1 must be OFF) Off: Disabled	Off
SW3-4	Incoming Call Beep, Speaker 2	On: Enabled (SW3-1 must be OFF) Off: Disabled	Off
SW3-5	Listen 2 to Right Headphone	On: Enabled (Monaural) Off: Disabled (Binaural)	On
SW3-6	Listen 2 to Speaker 1	On: Enabled (Binaural) Off: Disabled (Monaural)	Off
SW3-7	Listen 2 to Speaker 2	On: Enabled (Monaural) Off: Disabled (Binaural)	On
SW3-8	Listen 1 to Left Headphone	On: Enabled (Monaural) Off: Disabled (Binaural)	On

**TABLE 1.** Configuration Switch Table

---

## *Headset Microphone Type Selection DIP Switch*

SW1-1 applies only to a dynamic-mic headset connected to the dynamic-mic headset jack on the front panel. If the headset specifications indicate the microphone type is balanced, or if you are unsure, leave this switch in the off (default) position. If the specifications indicate an unbalanced microphone, set SW1-1 to on.

**NOTE:** For best results in noisy environments, a noise canceling (directional or cardioid) microphone is highly recommended. This is especially true if you are using the VOX feature.

---

## *Mic Kill Send Enable DIP Switch*

The MS-2002 can generate an inaudible signal which turns off the microphones on all intercom stations on a channel (for stations that detect this signal). This feature is useful, for example, when an unattended microphone has been left on and is causing unnecessary noise on a channel. By default, Mic Kill is not enabled.

To **activate Mic Kill Send**, do the following:

- > Set **SW1-6** to the on position.

---

## *Program Interrupt DIP Switches*

If you plan on using external program sources with the MS-2002, you have a choice of whether or not you want the program audio to shut off on the intercom channel while you are talking. By default, program audio does not interrupt during talk. You can change this as follows:

- > For channel 1 program interrupt during talk, set **SW1-7 to on**.  
OR  
For channel 2 program interrupt during talk, set **SW1-8 to on**.

---

## *Incoming Call Beep DIP Switches*

If call signal receive is enabled (switches SW1-3 and SW1-5), incoming calls will be indicated by red flashing Call keys. An optional beep tone can also be used. Internal switches enable the beep tone. You can then turn the beep tone on or off via the front panel during normal operation.

To **enable the beep tone**, do the following:

- > Verify the **call signal receive DIP switches are on** (SW1-3 and SW1-5).
  - For incoming call beep in a headset, set SW3-1 to **off**.
  - For incoming call beep in speaker 1, set SW3-1 to off and SW3-3 to **on**.
  - For incoming call beep in speaker 2, set SW3-1 to off and SW3-4 to **on**.

**NOTE:** For more information on turning incoming call beeps on or off during operation, see “Incoming Call Beep ON / OFF” on page 14.

---

## *Monaural or Binaural Operation DIP Switches*

The MS-2002 can be used with a single speaker or monaural headphones (single- or double-sided) for monaural operation. In this case, all audio signals are combined and sent to the headphones and the front panel speaker. The combined signals also go to the Speaker 1 jack on the back panel. The MS-2002 can also be used with two (2) speakers for binaural operation. In this case, channel 1 is sent to the Speaker 1 jack and channel 2 is sent to the Speaker 2 jack. Binaural headphone operation is not supported.

To **set monaural operation with headphones or one speaker (factory default)**, do the following:

1. Set **SW3-2** to off.
2. Set **SW3-5** to on.
3. Set **SW3-6** to off.
4. Set **SW3-7** to on.
5. Set **SW3-8** to on.

For binaural operation with two (2) speakers:

1. Set **SW3-2** to on.
2. Set **SW3-5** to off.
3. Set **SW3-6** to on.
4. Set **SW3-7** to off.
5. Set **SW3-8** to off.

---

## *Balanced Unbalance Switches*

Both of the BAL-UNBAL switches on the back panel are set at the factory to the balanced (BAL) position for use with Audiocom intercom channels. Set the switches to the unbalanced (UNBAL) position for use with a Clear-Com intercom system.

---

## *Direct Program Listen Enable / Disable Jumpers*

By default, each MS-2002 program input can be heard by all intercom stations listening on the corresponding intercom channel. This includes the MS-2002. Program input routing to the intercom channels can be turned on or off via the MS-2002 speaker or headset. This lets the MS-2002 operator hear the program inputs even if they are not being routed to the intercom channels.

To **disable direct program listening in the speaker or headset for one or more program inputs**, do the following:

- > Reset the **appropriate jumper** as shown in Table 2.

<b>Jumper</b>	<b>Description</b>	<b>Settings for Jumpers</b>
J3	Program 1 direct to Headset or Speaker	Pins 2 & 3 Shorted: Enabled Pins 1 & 2 Shorted: Disabled
J4	Program 2 direct to Headset or Speaker	Pins 2 & 3 Shorted: Enabled Pins 1 & 2 Shorted: Disabled

**TABLE 2.** Direct Program Listen Enable / Disable Jumpers

---

## *Mounting*

The MS-2002 mounts in a standard 19-inch equipment rack and is 1 **RU** (Rack Unit) high. When mounting the MS-2002, install the supplied black face plates on the appropriate side. The face plates should be mounted with the grooves on the top.

**NOTE:** You must perform the sidetone adjustment (page 10) after all components are connected. With the MS-2002 being rack mounted, you may not be able to access the sidetone trimmers. In this case, you can position the MS-2002 in the rack and make all required connections. Then, adjust the sidetone trimmers before installing and tightening all rack mount screws.

---

## *Connections*

Sample connection drawings are shown in figures 3 to 6.

---

## *External Program Input and PA Output*

Connection for external program input and PA output are shown in Figure 6 on page 18.

**REFERENCE:** For more information, see the EMS-4001 User Instruction Manual (P/N 9350-7713-000) which can be found at <http://www.telexaudiocom.com/manuals.php>.

---

## Cables

The numbers below correspond to the cable numbers in the connection drawings on the following pages.

- 1-channel intercom cable. Sold Separately. Use Telex ME cables, below. Or, build per Figure 7 on page 19.  
ME-25: 25' (7.6 m) cable with Male and Female 3-pin XLR connectors.  
ME-50: 50' (15.2 m) cable with Male and Female 3-pin XLR connectors.  
ME-100: 100' (30.4 m) cable with Male and Female 3-pin XLR connectors.

**NOTE:** When connecting from the MS-2002 to a TW-7W, keep cables as short as possible. Also, heavier gage wire is recommended.

- 2-channel intercom cable. Sold separately. Use Telex ME/2 cables, below. Or build per Figure 7.  
ME-25: 25' (7.6 m) cable with Male and Female 6-pin XLR connectors.  
ME-50: 50' (15.2 m) cable with Male and Female 6-pin XLR connectors.  
ME-100: 100' (30.4 m) cable with Male and Female 6-pin XLR connectors.
- Y adapter cable. Sold Separately. Use Telex CA-23-16. Or, build per Figure 7 on page 19.
- 3 ft. (0.91 m) speaker cable with RCA plugs. One (1) supplied with each SPS-2001, and SPK-2000.
- 18" (457 mm) EXP IN/OUT cable, stereo miniplug to stereo miniplug. One (1) supplied with each EMS-4001.
- 18" (457 mm) CHANNEL OUTPUT cable, 15-pin Male D-Sub to 15-pin Male D-Sub. One (1) supplied with each EMS-4001. (Optional component.)

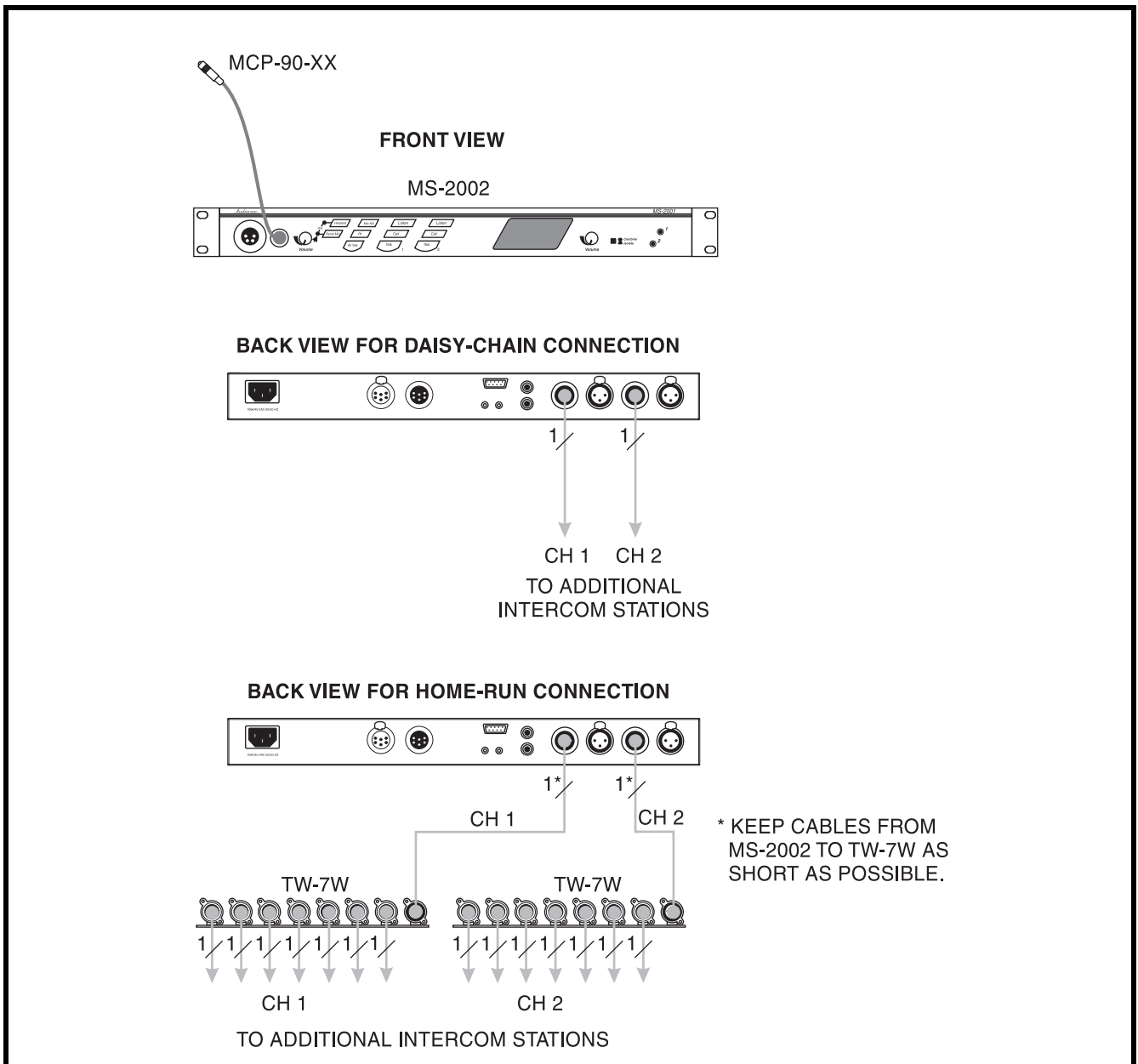
**REFERENCE:** See EMS-4001 User Manual (P/N 93507713-000) which can be found at <http://www.telexaudiocom.com/manuals.php> for connection information.)

- Shielded patch cable, 9-pin Male D-Sub to 9-pin Female D-Sub. Customer local purchase. Available at most electronic stores.

**NOTE:** All pins must be connected straight through: do not use an RS-232 computer cable.

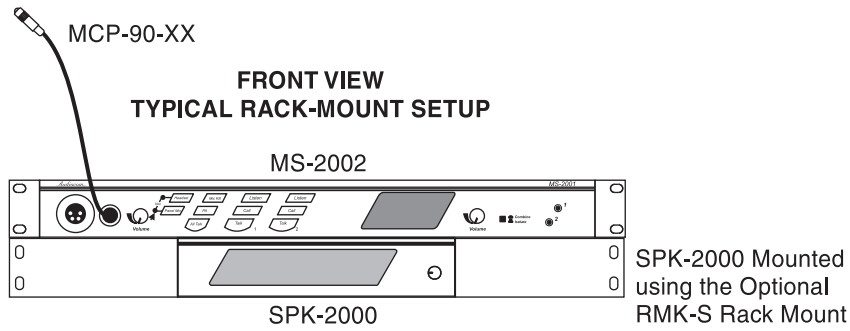
- Shielded patch cable, stereo miniplug to stereo miniplug. Customer local purchase. Available at most electronic stores.
- Shielded audio cable. Must have male 3-pin XLR connector at one (1) end for connection to the XP-USPG or XP-4PGM program inputs. Pin-out for program inputs is as follows:
  - Pin 1: common
  - Pin 2: + program input
  - Pin 3: - program input
- Shielded audio cable. Must have male 3-pin XLR connector at one(1) end for connection to the XP-USPG PA output. Pin-out for PA output is as follows:
  - Pin 1: common
  - Pin 2: + program input
  - Pin 3: - program input
- 18" (457 mm) CHANNEL OUTPUT cable, 15-pin Male D-Sub to 15-pin Female D-Sub. One (1) supplied with each XP-ES4000A. (Optional component.)

**REFERENCE:** See EMS-4001 User Manual (P/N 93507713000) which can be found at <http://www.telexaudiocom.com/manuals.php> for connection information

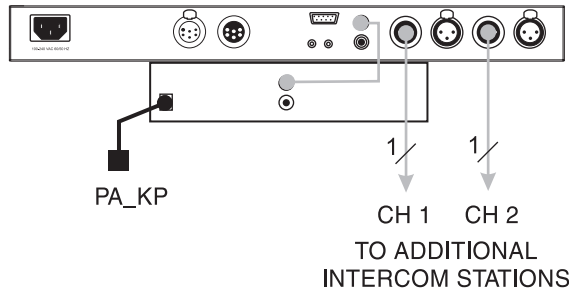


**FIGURE 3.** MS-2002 Monaural Master Speaker Station Configuration.

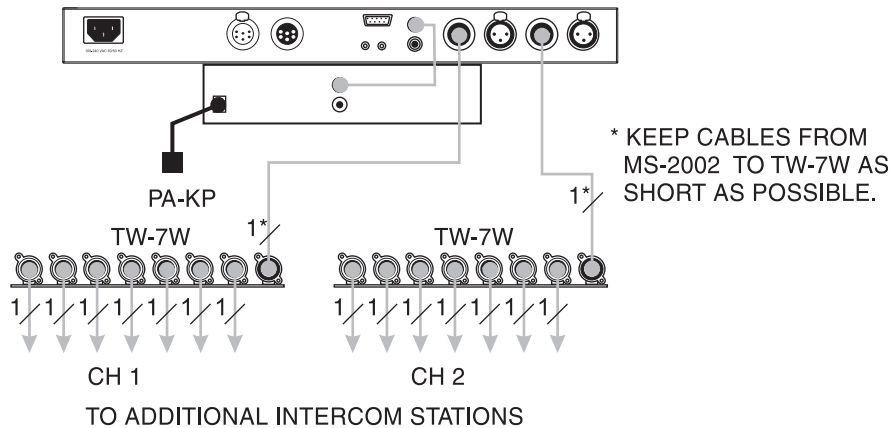
A good configuration for smaller intercom systems when you want to operate the MS-2002 as a master speaker station, with one (1) speaker to monitor both intercom channels. In this configuration, the Combine/Isolate switch is set to the Isolate position. With this setting, the two (2) intercom channels are completely separated. The MS-2002 dip switches are set to monaural operation so that both intercom channels are heard in the speaker.



**BACK VIEW FOR DAISY-CHAIN CONNECTION**



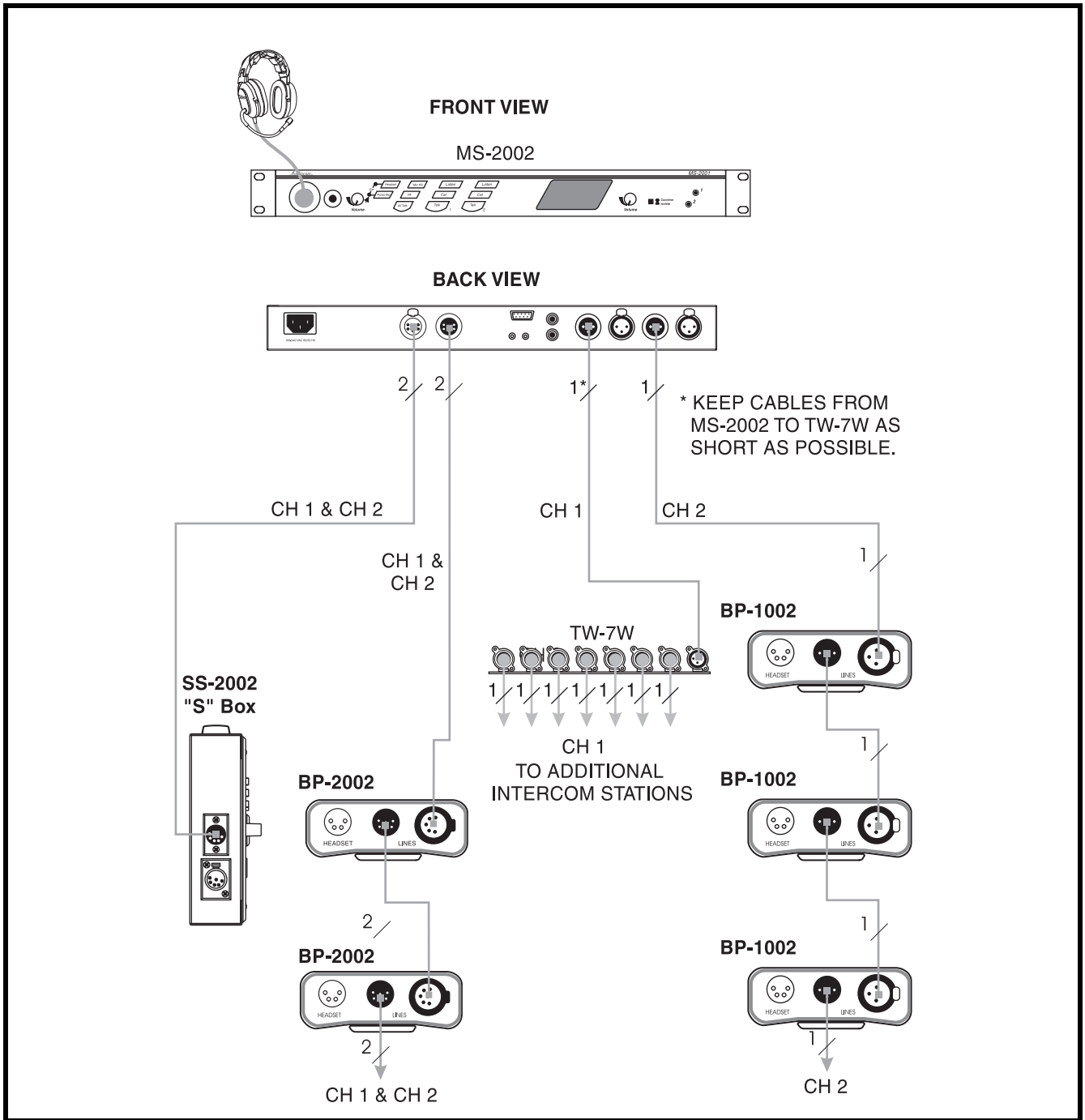
**BACK VIEW FOR HOME-RUN CONNECTION**



**FIGURE 4.** MS-2002 Binaural Master Speaker Station Configuration.

A good configuration for smaller intercom systems when you want to operate the MS-2002 as a master speaker station, with a separate speaker for each intercom channel. Make sure the MS-2002 intercom DIP switches are set for binaural speaker operation on page 12. Also, set the Combine/Isolate switch to the Isolate position. With this setting, the two (2) intercom channels are completely separated. The internal amplified speaker is used as the speaker output for channel 1, and the SPK-2000 is used for channel 2.

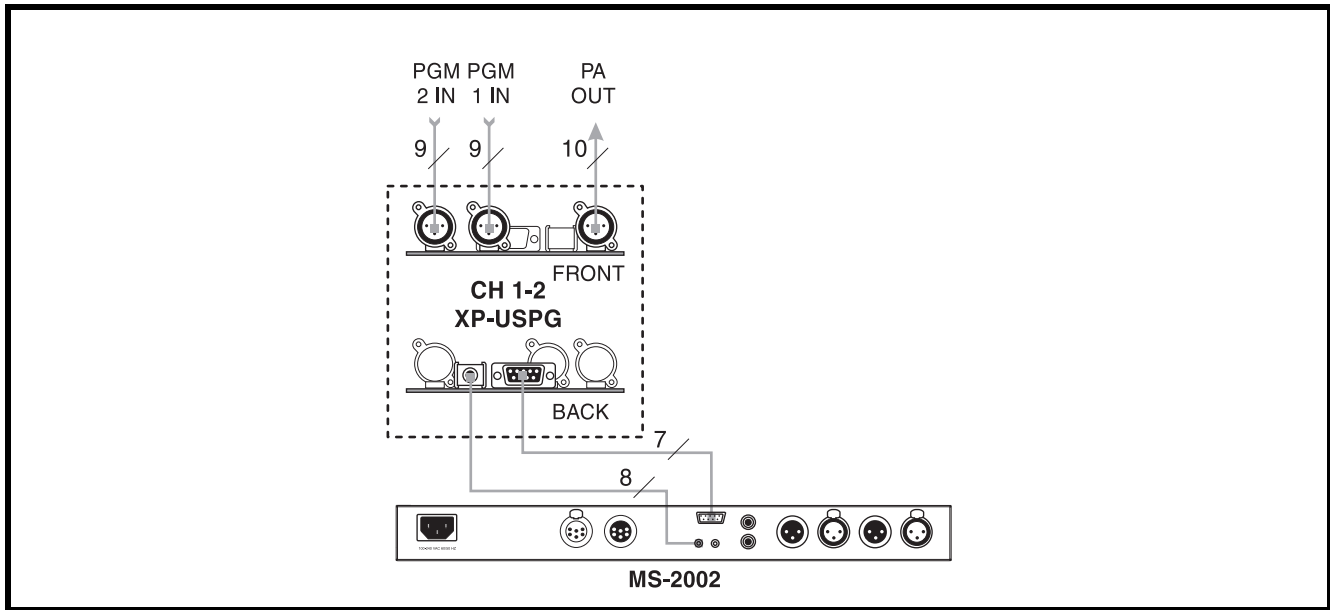




**FIGURE 5.** MS-2002 Typical Speaker Station and Belt Pack Connections.

Typically, a headset is connected to the front panel of the MS-2002, and the DIP switches are set to the monaural operation (default setting) so both intercom channels are heard in the monaural headphones (binaural headphone operation is not supported).

Belt packs use less power than speaker stations, and you can daisy-chain more of them on a single cable run. Avoid very long cable runs with daisy-chained speaker stations. This example shows how you would home run a SS-2002 speaker station when the cable is very long. Also, set the Combine/Isolate switch to the Isolate position. With this setting, the two (2) intercom channels are completely separate.

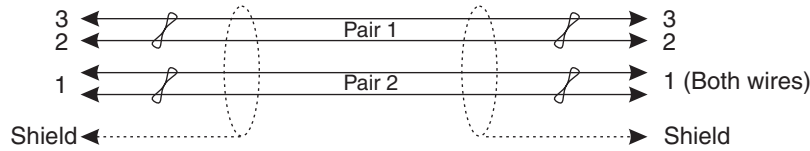


**FIGURE 6.** External Audio Input and PA Output.

You can connect two (2) audio sources to the Program Inputs connector: one (1) for each channel. Audio sources can be directly connected with a user-supplied DB9M connector. For more information on the program input connector specifications, see “Specifications” on page 15. However, a more convenient method is to use an XP-USPG Breakout Panel as shown. The XP-USPG also interfaces the PA jack of the MS-2002 to a standard, 2-pin XLR audio cable.

**NOTE:** The SP-USPG Breakout Panel can be rack mounted using a BOP-1000 Rack Mount Plate.

**TYPICAL 1-CHANNEL CABLE WIRING**



Cable Type: 22AWG Stranded, 2-Pair Twisted-wire, with Shield

Connector Type: 3-Pin XLR Audio (Neutrik or Switchcraft)\*

Pin 1: Common

Pin 2: Channel Audio / Power

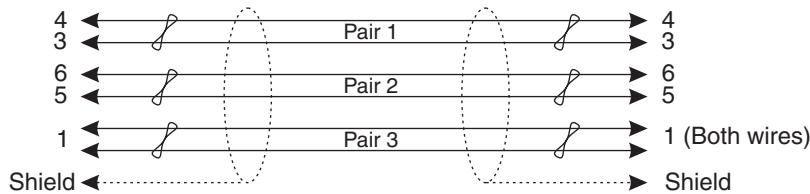
Pin 3: Channel Audio / Power

Shield: Earth ground

Denotes twisted pair.

Denotes shield.

**TYPICAL 2-CHANNEL CABLE WIRING**



Cable Type: 22AWG Stranded, 3-Pair Twisted-wire, with Shield

Connector Type: 6-Pin XLR Audio (Neutrik only, not compatible with 6-pin Switchcraft)\*

Pin 1: Channel 1 & 2 Common

Pin 2: No connection

Pin 3: Channel 1 Audio / Power

Pin 4: Channel 1 Audio / Power

Pin 5: Channel 2 Audio / Power

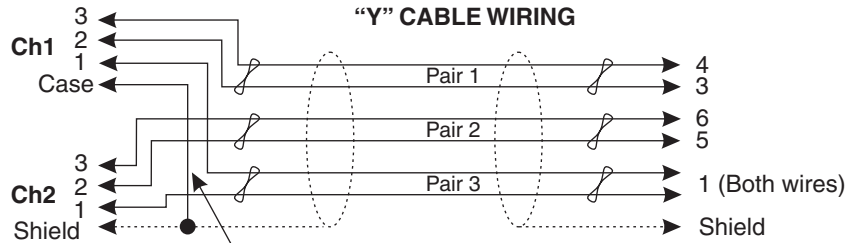
Pin 6: Channel 2 Audio / Power

Shield: Earth ground

Denotes twisted pair.

Denotes shield.

**“Y” CABLE WIRING**



Use second drain wire if available, or add an extra section of wire.

\* Standard cables are generally constructed using a male connector at one end and a female connector at the other end. This allows several cables to be interconnected to create longer cable runs. Audiocom master stations, speaker stations and belt packs also typically provide both a male and female Neutrik connector for each intercom channel. This permits loop-through connection of several intercom stations using the standard cables. Audiocom power supplies use a 3-pin male Neutrik connector for each channel. Audiocom wallplates use male Neutrik connectors.

**FIGURE 7.** Audiocom Intercom Cables



---

## *Operation and Specifications*

---

---

### *Power-Up Check*

To **power-up the MS-2002**, do the following:

- > Plug in the **MS-2002**.

*When power is first applied to the MS-2002, it performs a power-up reset, in which the front panel indicators cycle through all of their possible colors and then turn off. This verifies the general operation of the intercom station and indicators. The MS-2002 also reads the settings of all DIP switches at this time and configures itself accordingly.*

---

### *Test Tone*

The MS-2002 can generate a test tone, which can be used to verify intercom channels operation after installation or to locate a malfunction. This test tone is also used for the sidetone adjustment.

To **use the test tone**, do the following:

1. Simultaneously press the **All Talk** and **PA** keys to activate the test tone.
2. Tap the **call** key for the channel that you want to test (can be either a MS-2002 channel or an EMS-4001 channel).
3. Verify the **test tone** can be heard at all intercom stations on the channel.
4. Replace any **defective cable** or **intercom stations** where the test tone is being lost.
5. Tap the **same call key** to stop the test signal on that channel.
6. Press **any key**, except a Call key, to turn off the test tone.

---

## Sidetone Adjustment

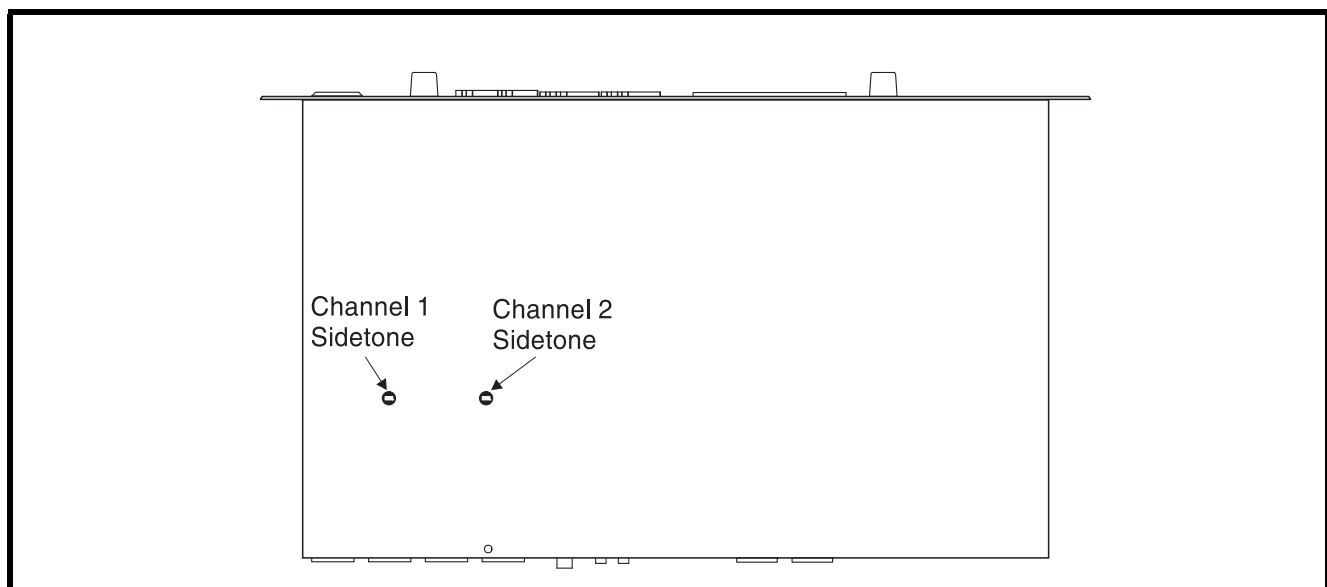
The MS-2002 uses full-duplex audio (the same as a conventional telephone line) where the talk and listen audio are sent and received on the same line. When you talk on a channel, you also hear your own voice back in the speaker or headphones. This is called sidetone. If you are using the MS-2002 with a microphone and speaker, sidetone could cause unwanted feedback, since the microphone may pick up your returned voice audio and reamplify it. This could also happen if you are using a headset when the ear cushions do not completely cover the ears, although it is probably much less likely. In either of these cases, you should minimize the amount of sidetone. On the other hand, if you are using headphones that completely enclose the ears, a certain amount of your own voice level is desirable to overcome the muffled sensation when talking. See Figure 8 on page 10, for the adjustment locations.

If you are using a speaker and microphone, or open-ear style headphones, **adjust the sidetone** as follows:

1. Simultaneously press the **All Talk** and **PA** keys to activate the test tone.
2. Tap the **channel 1 Call** key to send the test tone on channel 1.
3. Increase the **volume** until you can hear the test tone.
4. Using a small, flat-bladed screwdriver, adjust the **channel 1 sidetone** through the access hole in the bottom of the MS-2002 (Figure 8) to minimize the tone volume.
5. Tap the **channel 1 Call** key to turn off the test tone on channel 1 when finished.
6. Tap the **channel 2 Call** key, and repeat the adjustment for channel 2 sidetone.
7. Tap any **other key**, except a Call key, to turn off the test tone when finished.

If you are using headphones that completely enclose the ears, **adjust the sidetone** as follows:

1. Tap the **Headset** key to turn the headset microphone on.
2. Tap the **channel 1 Talk** key to turn it on.
3. While speaking into the microphone and using a small flat-blade screwdriver, adjust the **channel 1 sidetone** so you hear your voice at an acceptable level in the headphones.
4. Tap the **channel 1 Talk** key to turn it off when finished.
5. Tap the **channel 2 Talk** key to turn it on.
6. Adjust the **channel 2 sidetone** as for channel 1.
7. Tap the **channel 2 Talk** key to turn it off when finished.



**FIGURE 8.** MS-2002 Bottom View

---

## Voice-Activated Microphone (VOX) Setup

If you are going to use VOX, you must adjust the VOX level for proper operation. If the VOX level is too low, room noise activates the microphone. If the VOX level is too high, the microphone does not activate when you begin talking.

To **check and set the VOX level**, do the following:

1. If you are using a headset, tap the **Headset key twice** to turn on headset VOX.  
OR  
If you are using a panel microphone, tap the **Panel Mic key twice** to turn on panel mic VOX.  
*Whichever key you tap glows orange when the microphone is off and flickers or turns green when sound is picked up by the microphone.*
2. Position the **microphone** at its normal operation location.  
*If you are using a headset, put the headset on and position the microphone close to your mouth. Insure background noise is at the normal operating level.*

**IMPORTANT:** Do not speak into the microphone.

3. Observe the **Headset** or **Panel Mic** key, whichever you are using.
  - If the key is constantly glowing orange, turn the VOX trimmer clockwise until the key begins to flicker green (mic activating) then turn the trimmer slightly back in the counter-clockwise direction until the Panel Mic key just returns to steady orange (mic off).
  - If you are wearing a headset, make sure that breathing and movement do not cause the Panel Mic key to flicker green. If they do, adjust the VOX control slightly more in the counter-clockwise direction to eliminate this.
4. Speak into the **microphone** in a normal voice.
5. Verify the headset key immediately turns **green** when you talk.  
*If it does not, move the microphone closer to your mouth. If you are still unable to get satisfactory results, it may be the microphone does not have the directional characteristics required for the noise level in the room.*

### NOTE:

- A directional, or cardioid, microphone is recommended when using VOX.
  - When using omnidirectional microphones mode, the Mic Kill key is unlit; in programming mode it is lit continuously.
6. Tap the **Mic Kill key**.  
*The MS-2002 returns to normal operation if it has been left in programming mode.*

---

## Operation

**NOTE:** A quick reference to the following features can be found on the inside of the back cover.

### Normal vs. Programming Mode

The MS-2002 has two (2) operating modes:

- normal operating mode - the Mic Kill key is unlit.
- programming mode - the Mic Kill key is lit continuously.

To **return the MS-2002 to normal operation if it has been left in programming mode**, do the following:

- > Tap the **Mic Kill key**.

---

## Volume Adjustment

To **adjust the volume**, do the following:

- > If you are using a headset, adjust the **intercom listen level** with the left Volume control on the front panel of the MS-2002.  
OR  
If you are using a speaker, adjust the **intercom listen level** with the right Volume control next to the speaker.  
*External speakers require their own volume controls.*

## Receiving Calls

When there is an incoming call signal on a channel, the Call key for that channel flashes red. There is also a beep tone if the beep feature has been activated (page 14).

To **receive calls**, do the following:

1. Activate the **microphone**.
  - a. If you are using a dynamic-mic headset, tap the **Headset** key to turn the mic on.  
OR  
If you are using a panel-mounted microphone or an electret-mic headset, tap the **Panel Mic** key to turn the mic on.

**NOTE:** For more information about the voice-activated microphone (VOX) feature. See page 14.

2. Turn on the **Talk** and **Listen** keys for the calling channel and begin your conversation.
3. Turn off the **keys** when finished.

**NOTE:** When you tap the Headset key, or the Panel Mic key, or any Talk or Listen key, it locks in the on position. You can then tap the key again to turn it off. For momentary activation, press and hold the key. It remains on as long as you hold it and turns off when you release it.

## Call an Intercom Channel

To **call an intercom channel**, do the following:

1. Press and hold the **Call** key for the channel you want to call.  
*An inaudible call signal is sent, and your listen key for the channel is automatically turned on in preparation to receive a verbal response.*
2. When you hear a response, release the **Call** key.
3. If you are using manual microphone activation instead of VOX, make sure your microphone is **on**.  
OR  
For a dynamic mic headset, tap the **Panel Mic** key to turn it on.
4. Turn **on** the Talk key for the channel you called to begin your conversation.
5. Turn **off** the Talk and Listen keys to end the conversation.

## Microphone Mute During Talk

You can mute the microphone while talking.

To **mute the microphone during talk**, do the following:

1. Tap either the **Headset** key or the **Panel Mic** key, whichever is currently being used.
2. Tap the **key again** to turn the microphone back on. (If you are using VOX, tap the key twice to reactivate VOX.)



---

## All Talk

You can talk to all intercom stations that currently have their listen keys activated. This applies to both channels of the MS-2002, as well as all talk channels of any connected EMS-4001 Expansion Stations.

To use **All Talk**, do the following:

1. If you are using manual microphone activation instead of VOX, verify the **proper microphone switch** is turned on (either Headset or Panel Mic).
2. Press and hold the **All Talk key** while talking.
3. Release the **key** when finished.

**NOTE:** To insure the All Talk key is never accidentally left in the on position, it does not latch.

---

## Public Address

If the **PA** (Public Address) output on the back panel of the MS-2002 is connected to a public address system, you can talk on the public address system.

To use the **public address system**, do the following:

1. If you are using manual microphone activation instead of VOX, verify the **proper microphone switch** is turned on (either Headset or Panel Mic).
2. Press and hold the **PA key** while talking.
3. Release the **key** when finished.

**NOTE:** To insure the PA key is never accidentally left in the on position, it does not have latching operation.

## Turning the Program Inputs On and Off

To **turn the program inputs on and off**, do the following:

1. Verify **program inputs** have been connected at the back panel and that the program sources are on.
2. Press and hold the **Mic Kill** key for about two (2) seconds, then release it.  
*It should now be lit green to indicate that the MS-2002 is in programming mode.*

**NOTE:**The current status of the program inputs is indicated by the Talk keys. If the channel 1 Talk key is lit, the program 1 input is currently activated to channel 1; if the channel 2 talk key is lit, program 2 is activated to channel 2. Tap either **Talk** key to turn the program input on or off.

3. When the program inputs are configured as desired, tap the **Mic Kill** key to exit programming mode and return to normal operation.
4. Adjust **program 1 and 2 levels** via the trimmers on the back panel of the MS-2002.

---

## Using Mic Kill

If the **Mic Kill** feature has been enabled, you can use it to deactivate all talk keys on a single channel or on all channels. This feature is useful when a remote talk key has been left on and is causing unwanted noise on a channel.

---

## *Using Voice-Activated Microphone (VOX)*

If you use VOX, you do not have to insure the microphone key is turned on whenever you want to talk.

To **activate VOX**, do the following:

1. Verify the **Headset** and **Panel Mic** keys are off.
2. If you are using a headset, tap the **Headset key twice** to turn on headset VOX.

OR

If you are using a panel microphone, tap the **Panel Mic key twice** to turn on panel mic VOX.

*Whichever key you tap, it glows orange when the microphone is off and flickers or turns green when the microphone is off and flickers and turns green when the microphone turns on.*

**REFERENCE:** For more information on VOX adjustment, see “Voice-Activated Microphone (VOX) Setup”, page 14.

---

## *Incoming Call Beep ON / OFF*

Normally, incoming calls are indicated by red-flashing Call keys.

To **enable incoming call beep**, do the following:

**NOTE:** Ensure this **feature** has been activated via internal switches (page 11).

3. Press and hold the **Mic Kill Key** for about 2 seconds, then release it.  
*It should now be lit green to indicate the intercom station is in programming mode.*
4. Tap either **Call** key on the MS-2002 to turn the beep feature on or off.

**NOTE:** It does not matter which one you tap, since this feature affects both channels.

5. Tap the **Mic Kill** key to return to normal operation.

---

## Specifications

### General

#### Power Requirements:

AC Input: 100-240VAC, 50/60Hz

Channel Power: 24VDC nominal (12 to 30 VDC), 65 to 150mA

*MS2002 is capable of supplying 2 amps overall (1 Amp per channel)*

#### Dimensions:

1.75" (44.5mm) high x 19" (483mm) wide x 10.31" (261.9mm) deep

#### Weight:

Approximately 4.5lb. (2kg)

#### Environmental Requirements:

Storage: -20°C to 80°C (-4°F to 176°F)

0% to 95% humidity, non-condensing

Operating: -15°C to 60°C (5°F to 140°F)

0% to 95% humidity, non-condensing

### Dynamic-mic Headset

#### Microphone:

50 to 200 Ohm, dynamic (balanced or unbalanced)

#### Headphones:

150 to 600 Ohm, monaural

#### Connector Type: XLR-4M

Pin 1 - Microphone low

Pin 2 - Microphone high

Pin 3 - Headphone high

Pin 4 - Headphone low

### Panel Microphone Input

**Microphone Type:** Electret condenser

#### Power:

Phantom (+5VDC)

#### Nominal Level:

-42dBu

#### Maximum Level:

-25dBu

#### Connector Type:

IKP12 (MCP-90 series, stereo plug connector)

### Program Input

#### Input Level:

100mV maximum

#### Voltage Gain:

25 ±3dB

#### Output Level (to intercom channel):

1.0VRMS nominal, 2.3VRMS max.

#### Input Impedance:

75k Ohm

#### Common Mode Rejection:

Greater than 50dB

**Connector Type:** 9-pin female D-Sub (DE9S)

Pin 1	Ground
Pin 2	Program 1 input low
Pin 3	Program 2 input low
Pin 4	NC
Pin 5	NC
Pin 6	Program 1 input high
Pin 7	Program 2 input high
Pin 8	NC
Pin 9	NC

### Intercom Channels, Balanced Mode (Both Back Panel and Internal Switches (BAL/UNBAL) must be set to the same setting)

#### Output Level:

1VRMS nominal

#### Input Impedance:

300 Ohm

#### Bridging Impedance:

Greater than 10,000 Ohm

#### Sidetone:

-40dB, 35dB, adjustable range

#### Call Signaling:

Send: 20kHz ±100 Hz, 0.5VRMS ±10%

Receive: 20kHz ±800 Hz, 100mVRMS

#### Mic-Kill Frequency:

Send: 24kHz ±300Hz, 0.5VRMS ±10%

Detect: 24kHz ±800Hz, 100mVRMS

#### Noise Contribution:

Less than -70dB

#### Common Mode Rejection Ratio:

Greater than 50dB

**Connector Type:** One (1) XLR-3M and XLR-3F pair, wired in parallel, for each channel (permits "loop-thru" connection). Two (2) XLR-6M (Neutrik) connectors for 2-channel connection

#### *XLR-3 Balanced Configuration Pinouts*

Pin 1 Common

Pin 2 Intercom audio low and +24 VDC input

Pin 3 Intercom audio high and +24 VDC input

#### *XLR-6 Balanced Configuration Pinouts*

Pin 1 Audio and DC Common

Pin 2 Local Power (12 to 15 VDC, 65 to 150mA)

Pin 3 Intercom channel 1 audio low and +24VDC phantom power

Pin 4 Intercom channel 1 audio high and +24VDC phantom power

Pin 5 Intercom channel 2 audio low and +24VDC phantom power

Pin 6 Intercom channel 2 audio high and +24VDC phantom power

### Intercom Channel, Unbalanced Mode (Both Back Panel and Internal Switches (BAL / UNBAL) have to be set to the same setting).

#### Output Level:

1VRMS ±10%

#### Input Impedance:

150 Ohm

#### Bridging Impedance:

Greater than 10,000 Ohm

#### Call Signaling:

Send: 11 ±3VDC

Receive: 4VDC minimum

---

**Connector Type:** Uses same connectors as for balanced mode, above, but without pinouts modified by BAL/UNBAL switch on back panel as follows

*XLR-3 Unbalanced Configuration Pinouts*

- Pin 1 Common
- Pin 2 +24 VDC input
- Pin 3 Intercom audio high

*XLR-6 Unbalanced Configuration Pinouts*

- Pin 1 Common
- Pin 2 Local Power (12 to 15 VDC, 65 to 150mA)
- Pin 3 Channel 1 +24 VDC input
- Pin 4 Channel 1 Intercom audio high and DC call
- Pin 5 Channel 2 +24 VDC input
- Pin 6 Channel 1 Intercom audio high and DC call

**PA Output**

**Output Level:**

235 mVRMS nominal

**Connector Type:** 3.5mm Stereo Phone Jack

Tip: PA output high  
Ring: Not used  
Sleeve: Common

**Speaker Output**

**Output Level:**

0dB nominal (1.0VRMS)

**Output Impedance:**

1000 Ohm nominal

**Frequency Response:**

200Hz to 8kHz +1/-3dB

**Connector Type:** RCA Phono Jack

Tip: Speaker output high  
Sleeve: Common

**Expansion Input/Output**

**Type:**

3.5mm stereo phone jack  
Tip: Tip Output  
Ring: Listen input  
Sleeve: Common

**Headphone Amplifier**

**Voltage Gain:**

30 ±3dB

**Maximum Output:**

250mW ±10% into 150 Ohm, 65mW ±10% into 600 Ohm

**Frequency Response:**

200Hz to 8kHz +1/-3dB

**Incoming Call Beep Tone:**

2kHz, at the headphones

**Total Harmonic Distortion:**

Less than 0.2% at 200mW

**Sidetone:**

18 ±dB, adjustable

---

## Quick Reference

Description	Action
Reset MS-2002	Press All Talk and Listen 1
Reset EMS-4001	Press All Talk and Listen 5
Test signal on	Press All Talk and PA, then tap Call
Test signal off	Tap Call, then tap any other key
Mic latched on	Tap Headset or Panel Mic (key is green)
Mic latched off	Tap Headset or Panel Mic
Mic momentary on	Hold Headset or Panel Mic
VOX mode on	Tap twice: Headset or Panel Mic
VOX mode off	Tap Headset or Panel Mic
All talk on	Hold All Talk when Headset or Panel Mic is lit (All Talk key is green)
All talk off	Release All Talk
Public address	Hold PA when Headset or Panel Mic is lit (PA key is green)
Mic kill, one channel	Tap Mic Kill, then tap Talk or Listen (Mic Kill key will blink green and the Talk and listen keys are green). Tap Mic Kill to exit
Mic kill, all channels	Tap Mic Kill, then tap All Talk (Mic Kill key will blink green and all Talk and Listen keys are green). Tap Mic Kill to exit
Program ON	Hold Mic Kill, then tap channel's Talk key (key is green). Tap Mic Kill to exit.
Program off	Hold Mic Kill, then tap the channel's talk key. Tap Mic Kill to exit
Audible call alert on	Hold Mic Kill, then tap either Call (all Call keys are red). Tap Mic Kill to exit
Audible call alert off	Hold Mic Kill, then tap either Call. Tap Mic Kill to exit
Turn mic kill key off	Tap Mic Kill
Talk latched on	Tap Talk (key is green)
Talk latched off	Tap Talk
Talk momentary on	Hold Talk
Talk momentary off	Release Talk
Call signal on	Hold Call
Call signal off	Release Call
Receive call signal	(Call key blinks red)
Listen latched on	Tap Listen (key is green)
Listen latched off	Tap Listen
Listen momentary on	Hold Listen

