

Model MDA-100
Mixing Distribution Amplifier
User Manual



Proprietary Notice

The product information and design disclosed herein were originated by and are the property of Bosch Security Systems, Inc. Bosch reserves all patent, proprietary design, manufacturing, reproduction, use and sales rights thereto, and to any article disclosed therein, except to the extent rights are expressly granted to others.

Copyright Notice

Copyright 2009 by Bosch Security Systems, Inc. All rights reserved. Reproduction, in whole or in part, without prior written permission from Bosch is prohibited.

Warranty Notice

See the enclosed warranty card for further details.

Customer Support

Technical questions should be directed to:

Customer Service Department
Bosch Security Systems, Inc.
12000 Portland Avenue South
Burnsville, MN 55337 USA
info@rtsintercoms.com
Telephone: 800-392-3497
Fax: 800-323-0498

Technical Questions EMEA:
Bosch Security Systems Technical Support EMEA
http://www.rtsintercoms.com/contact_main.php

Return Shipping Instructions



Customer Service Department
Bosch Security Systems, Inc. (Lincoln, NE)
Telephone: 402-467-5321
Fax: 402-467-3279
Factory Service: 800-553-5992

Please include a note in the box which supplies the company name, address, phone number, a person to contact regarding the repair, the type and quantity of equipment, a description of the problem and the serial number(s).

Shipping to the Manufacturer

All shipments of product should be made via UPS Ground, prepaid (you may request from Factory Service a different shipment method). Any shipment upgrades will be paid by the customer. The equipment should be shipped in the original packing carton. If the original carton is not available, use any suitable container that is rigid and of adequate size. If a substitute container is used, the equipment should be wrapped in paper and surrounded with at least four (4) inches of excelsior or similar shock-absorbing material. All shipments must be sent to the following address and must include the Proof of Purchase for warranty repair. Upon completion of any repair the equipment will be returned via United Parcel Service or specified shipper, collect.

Factory Service Department
Bosch Security Systems, Inc.
8601 East Cornhusker Hwy.
Lincoln, NE 68507 U.S.A.
Attn: Service

| | | |
|---|---|---|
|  THE LIGHTNING FLASH AND ARROWHEAD WITHIN THE TRIANGLE IS A WARNING SIGN ALERTING YOU OF "DANGEROUS VOLTAGE" INSIDE THE PRODUCT. | CAUTION RISK OF ELECTRIC SHOCK DO NOT OPEN CAUTION: TO REDUCE THE RISK OF ELECTRIC SHOCK, DO NOT REMOVE COVER. NO USER-SERVICABLE PARTS INSIDE. REFER SERVICING TO QUALIFIED SERVICE PERSONNEL. |  THE EXCLAMATION POINT WITHIN THE TRIANGLE IS A WARNING SIGN ALERTING YOU OF IMPORTANT INSTRUCTIONS ACCOMPANYING THE PRODUCT. |
| SEE MARKING ON BOTTOM/BACK OF PRODUCT | | |
| WARNING: APPARATUS SHALL NOT BE EXPOSED TO DRIPPING OR SPLASHING AND NO OBJECTS FILLED WITH LIQUIDS, SUCH AS VASES, SHALL BE PLACED ON THE APPARATUS. | | |
| WARNING: THE MAIN POWER PLUG MUST REMAIN READILY OPERABLE. | | |
| CAUTION: TO REDUCE THE RISK OF ELECTRIC SHOCK, GROUNDING OF THE CENTER PIN OF THIS PLUG MUST BE MAINTAINED. | | |
| WARNING: TO REDUCE THE RISK OF FIRE OR ELECTRIC SHOCK, DO NOT EXPOSE THIS APPRATUS TO RAIN OR MOISTURE. | | |
| WARNING: TO PREVENT INJURY, THIS APPARATUS MUST BE SECURELY ATTACHED TO THE FLOOR/WALL/RACK IN ACCORDANCE WITH THE INSTALLATION INSTRUCTIONS. | | |
|  | This product is AC only. | |

Important Safety Instructions

1. Read these instructions.
2. Keep these instructions.
3. Heed all warnings.
4. Follow all instructions.
5. Do not use this apparatus near water.
6. Clean only with dry cloth.
7. Do not block any ventilation openings. Install in accordance with the manufacturer's instructions.
8. Do not install near any heat sources such as radiators, heat registers, stoves, or other apparatus (including amplifiers) that produce heat.
9. Do not defeat the safety purpose of the polarized or grounding-type plug. A polarized plug has two blades with one wider than the other. A grounding type plug has two blades and a third grounding prong. The wide blade or the third prong are provided for your safety. If the provided plug does not fit into your outlet, consult an electrician for replacement of the obsolete outlet.
10. Protect the power cord from being walked on or pinched particularly at plugs, convenience receptacles, and the point where they exit from the apparatus.
11. Only use attachments/accessories specified by the manufacturer.
12. Use only with the cart, stand, tripod, bracket, or table specified by the manufacturer, or sold with the apparatus. When a cart is used, use caution when moving the cart/apparatus combination to avoid injury from tip-over.
13. Unplug this apparatus during lightning storms or when unused for long periods of time.
14. Refer all servicing to qualified service personnel. Servicing is required when the apparatus has been damaged in any way, such as power-supply cord or plug is damaged, liquid has been spilled or objects have fallen into the apparatus, the apparatus has been exposed to rain or moisture, does not operate normally, or has been dropped.

Safety Summary

Power Source

This equipment is designed to operate from an AC power source, as described in the electrical specifications.

Grounding

The chassis of this product is grounded through the grounding pin of the line cord. To avoid electrical shock, with the power off, plug the line cord into a properly wired receptacle before making any input or output connections with other devices. Use only the line cord specified for your unit. Ensure the line cord is in good condition and free of kinks.

Caution

CAUTION: A protective ground connection through the grounding conductor of the line cord is essential for safe operation.

Fusing

This product is fitted with a fuse. All fuse replacement related instructions are located in the service manual.

Table of Contents

| | |
|---|-----------|
| <i>IMPORTANT SAFETY INSTRUCTIONS</i> | 3 |
| <i>Power Source</i> | 5 |
| <i>Grounding</i> | 5 |
| <i>Caution</i> | 5 |
| <i>Fusing</i> | 5 |
| INTRODUCTION | 7 |
| <i>Description and Specifications</i> | 7 |
| <i>DESCRIPTION</i> | 7 |
| <i>SPECIFICATIONS</i> | 8 |
| INSTALLATION | 11 |
| <i>Preparation</i> | 11 |
| <i>Power Connection</i> | 11 |
| <i>Audio Connections</i> | 12 |
| <i>J1 CONNECTOR</i> | 12 |
| <i>J2 CONNECTOR</i> | 13 |
| <i>J3 CONNECTOR</i> | 13 |
| <i>J4 CONNECTOR</i> | 14 |
| <i>J 5 CONNECTOR</i> | 14 |
| <i>J6 CONNECTOR</i> | 15 |
| <i>J7 CONNECTOR</i> | 15 |
| <i>Audio Level Settings</i> | 16 |
| <i>SUMMING AMPLIFIER</i> | 16 |
| <i>DISTRIBUTION AMPLIFIER</i> | 16 |

*Description and Specifications***Description**

The MDA-100 Mixing and Distribution Amplifier contains an 8 x 1 summing amplifier (also known as a mixer) and a 1 x 8 distribution amplifier in a case that is 1 **RU** (Rack Unit) high. The MDA-100 is useful, for example, in **CCU** (Camera Control), where multiple camera operators have to talk and listen to one master control location. In this application, audio from each camera, up to eight (8), is fed to one of the summing amplifier inputs of the MDA-100. All eight (8) audio inputs are summed and fed to the master controller input. The return audio path from the master controller back to the individual cameras is accomplished using the distribution amplifier, which takes the single audio output from the master controller and distributes it to each of the eight camera outputs.

The gain of each summing amplifier input may be individually adjusted by a trimmer on the front panel of the MDA-100. There is also an output adjustment trimmer located inside the MDA-1000 to adjust the final output level of the summing amplifier. The summing amplifier output is a 60 Ohm voltage source.

The distribution amplifier has a separate output level trimmer for each output. These trimmers are located on the front panel. All the outputs are 60 Ohm voltage sources. The input impedances may be set for bridging (20 kOhms), 150 Ohms, or 600 Ohms, selected by rear panel jumpers.

The MDA-100 fits into a standard 19" (483mm) equipment rack. The power entry module is an IEC approved type, which contains a line voltage switch, a line filter, a fuse holder, and a line cord socket connector. The line voltage switch may be set for either 105/125Vac, 50/60Hz, or 210/250Vac, 50/60Hz supply voltages. The MDA-100 features a torroidal-transformer power supply for low-noise operation.

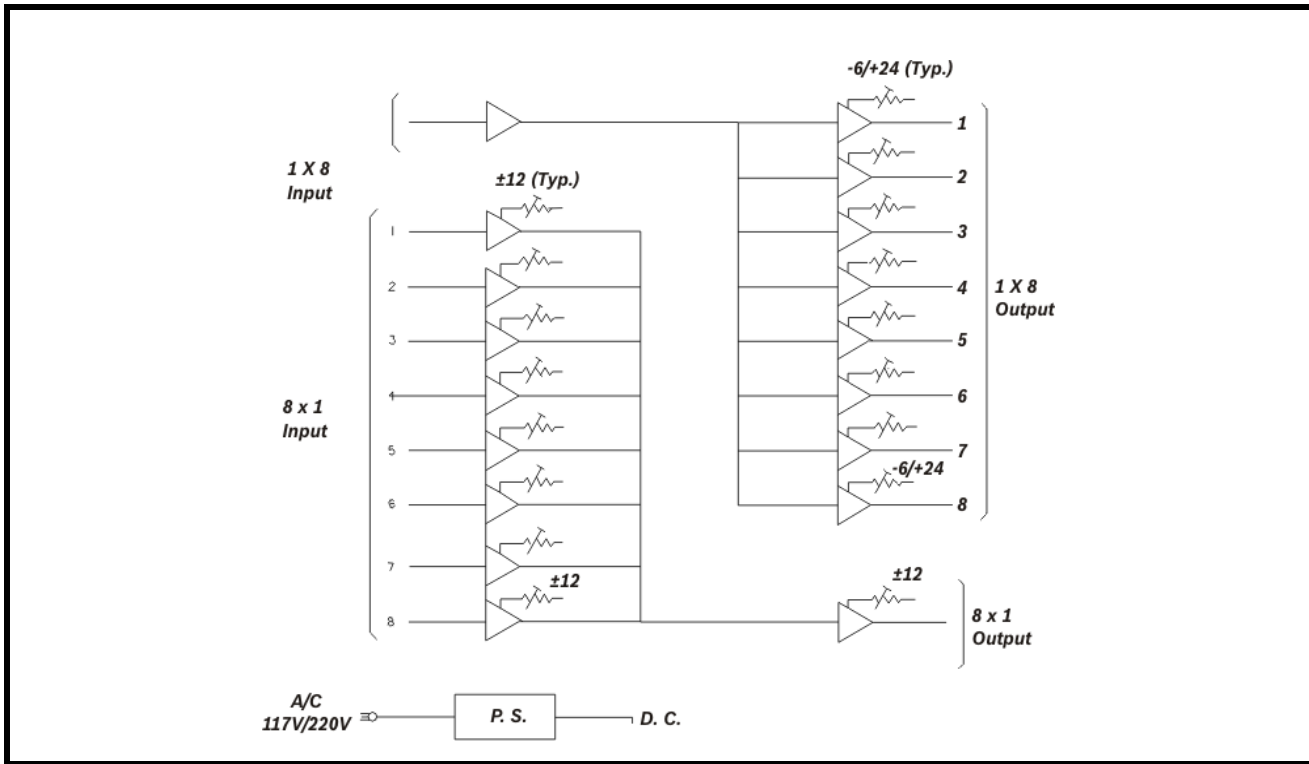

FIGURE 1. Functional Diagram – MDA-100 Mixing Distribution Amplifier

Specifications

General

Power Consumption

20Watts Maximum; 110Vac or 220Vac nominal, 10%, 50/60Hz

Operating Temperature Range

0°–50°C (32°–122°F)

Dimensions

Width: 19 inches (483mm)

Height: 1.75 inches (44mm)

Depth: 8.5 inches (213mm)

Weight

9 lbs. (4.1kg)

Summing Amplifier (8 x 1)

Input Level

-20dBm to +24dBm

Input Impedance

>20kOhm, active, balanced

Output Level

+28dBu, maximum

Output Source Impedance

600 Ohm, active, balanced

Gain Adjustment

± 12 dB (Front Panel) per input, ± 12 dB (internal) output trim.

Frequency Response

0 to -0.2 dB, 20Hz to 20kHz, referenced to 1kHz

Distribution Amplifier (1 x 8)

Input Level

-22 to $+14$ dBu nominal for $+8$ dBm output. Maximum $+28$ dBu

Input Type and Impedance

Active balanced, 20kOhm, 600 Ohm, or 150 Ohm, selectable

Output Level

$+28$ dBu, maximum, 60 Ohms

Output Source Impedance

60 Ohms, active, balanced

Output Isolation

>80 dB, 20Hz to 20kHz

Output DC Offset

$<\pm 50$ mVdc

Gain Adjustment

Each output independently adjustable for -6 dB to $+28$ dB (34dB)

Frequency Response

0 to -0.2 dB, 20Hz to 20kHz, referenced to 1kHz

Noise

124dB below maximum output at unity gain (20Hz to 20kHz). Nominally 114dB below at $+18$ dBu, unity gain (20Hz to 20kHz). Typically 104dB below $+8$ dBm.

Total Harmonic Distortion

$<0.01\%$ (20Hz to 20kHz) at unity gain. Up to $+28$ dBu output level

Inter-modulation Distortion

0.008% at unity gain. Up to $+28$ dBu output level (4:1 ratio). Typically $<0.001\%$ at $+8$ dBu

Common Mode Rejection

>80 dB, 20Hz to 20kHz. Typically 96dBu at 1kHz (adjustable).

Common Mode Voltage

100V peak-to-peak, maximum

Preparation

The MDA-100 fits in 19" (483mm) wide standard equipment racks, consoles and turrets. Prepare the equipment rack for installation of the MDA-100, and locate a suitable power source.

Power Connection

Before plugging in the power cord, verify the voltage selector switch is set to the correct voltage.

To **correctly set the voltage selector**, do the following:

- > Use a flat-head screwdriver to align the **white dot with 110 or 220**, depending on your supply voltage.

To **power up the MDA-100**, do the following:

1. Plug the **power cord** into the MDA-100.
2. Plug the **other end** into an AC outlet

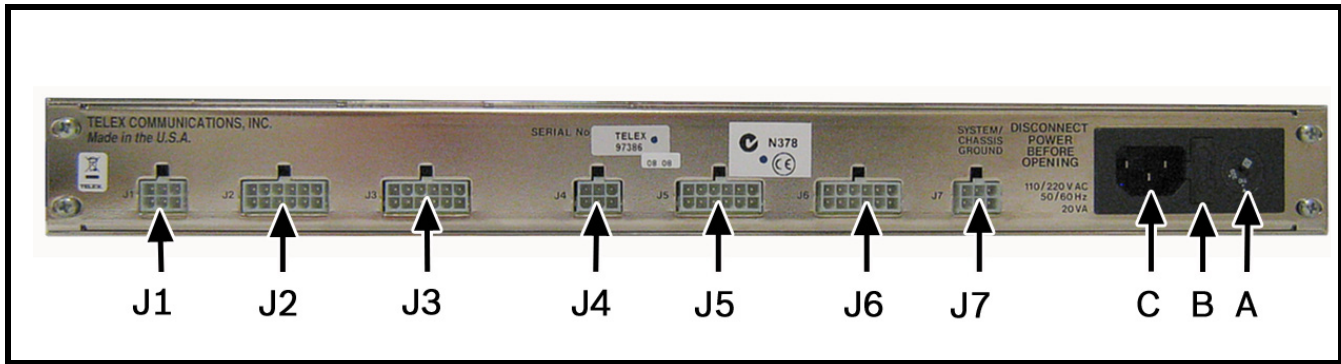

FIGURE 2. Rear Panel Layout – MDA-100 Distribution Amplifier

- J1 - Summing amplifier output
- J2 - Summing amplifier inputs 5–8
- J3 - Summing amplifier inputs 1–4
- J4 - Distribution amplifier input termination select
- J5 - Distribution amplifier outputs 5–8
- J6 - Distribution amplifier outputs 1–4
- J7 - System/Chassis ground
- A - Voltage selector switch
- B - Fuse and fuse holder
- C - Line cord receptacle

Audio Connections

All connections to the MDA-100 are made on the rear panel using the mating Molex connectors from the supplied connector kit. Wires should be 18–24 AWG shielded twisted pairs. The required tools for crimping and extraction of wires are not supplied with the MDA-100. These tools may be obtained from <http://www.molex.com>.

The following illustrations are views of the mating connectors as seen from the side where wires are inserted.

J1 Connector

TABLE 1. Summing Amp Output

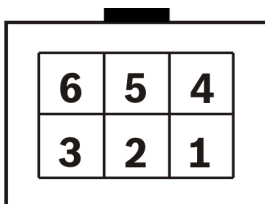

| Pin | Function |
|-----|----------------|
| 1 | + Audio Output |
| 2 | Shield |
| 3 | - Audio Output |
| 4 | Not Used |
| 5 | Shield |
| 6 | Not Used |

J2 Connector

TABLE 2. Summing Amp Inputs 5-8

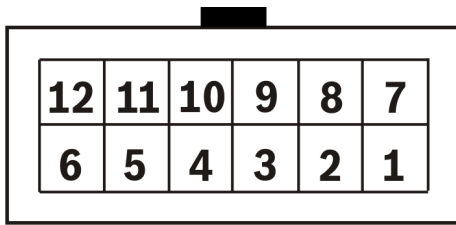

| Pin | Function |
|-----|---------------|
| 1 | + Input No. 5 |
| 7 | - Input No. 5 |
| 2 | Shield No. 5 |
| 3 | +Input No. 6 |
| 9 | - Input No. 6 |
| 5 | Shield No. 6 |
| 4 | +Input No. 7 |
| 10 | - Input No. 7 |
| 8 | Shield No. 7 |
| 6 | +Input No. 8 |
| 12 | - Input No. 8 |
| 11 | Shield No. 8 |

J3 Connector

TABLE 3. Summing Amplifier Inputs 1-4

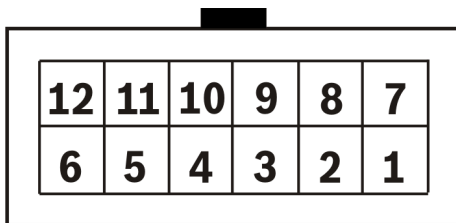

| Pin | Function |
|-----|---------------|
| 1 | + Input No. 1 |
| 7 | - Input No. 1 |
| 2 | Shield No. 1 |
| 3 | +Input No. 2 |
| 9 | - Input No. 2 |
| 5 | Shield No. 2 |
| 4 | +Input No. 3 |
| 10 | - Input No. 3 |
| 8 | Shield No. 3 |
| 6 | +Input No. 4 |
| 12 | - Input No. 4 |
| 11 | Shield No. 4 |

J4 Connector

TABLE 4. Distribution Amp Input Termination

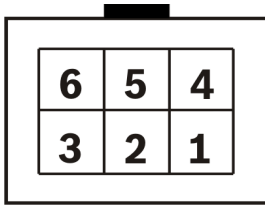

| Pin | Function |
|-----|---------------|
| 1 | + Audio Input |
| 3 | - Audio Input |
| 2 | Shield |
| 4 | See Note |
| 5 | Shield |
| 6 | See Note |

NOTE: If the audio source requires a 600 Ohm termination, install a jumper across pins 4 and 6. If the source requires a 150 Ohm termination, jumper pin 3 to 4 and pin 1 to 6. For bridging input leave pins 4 and 6 open.

J5 Connector

TABLE 5. Distribution Outputs 5–8

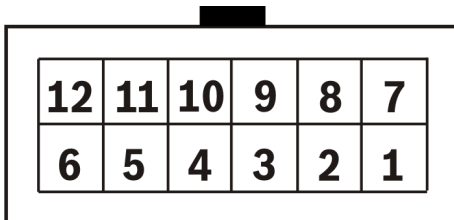

| Pin | Function |
|-----|----------------|
| 1 | + Output No. 5 |
| 7 | - Output No. 5 |
| 2 | Shield No. 5 |
| 3 | + Output No. 6 |
| 9 | - Output No. 6 |
| 5 | Shield No. 6 |
| 4 | +Output No. 7 |
| 10 | - Output No. 7 |
| 8 | Shield No. 7 |
| 6 | +Output No. 8 |
| 12 | - Output No. 8 |
| 11 | Shield No. 8 |

J6 Connector

TABLE 6. Distribution Outputs 1–4

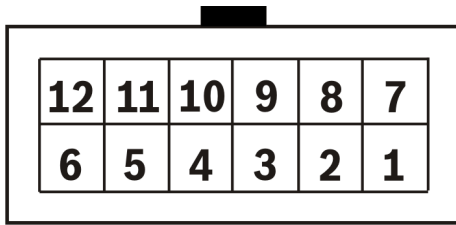

| Pin | Function |
|-----|----------------|
| 1 | + Output No. 1 |
| 7 | - Output No. 1 |
| 2 | Shield No. 1 |
| 3 | +Output No. 2 |
| 9 | - Output No. 2 |
| 5 | Shield No. 2 |
| 4 | +Output No. 3 |
| 10 | - Output No. 3 |
| 8 | Shield No. 3 |
| 6 | +Output No. 4 |
| 12 | - Output No. 4 |
| 11 | Shield No. 4 |

J7 Connector

TABLE 7. Chassis and Audio Ground

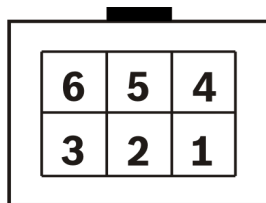

| Pin | Function |
|-----|----------------|
| 1 | Chassis ground |
| 2 | Chassis ground |
| 4 | Chassis ground |
| 3 | Audio common |
| 5 | Audio common |
| 6 | Audio common |

NOTE:

- As supplied, the MDA-100 chassis ground is connected to earth ground through the line cord, and the audio ground is isolated from earth ground.
- Your installation may require the audio ground be connected to some reference other than earth ground. In this case, connect your ground reference to pins 3, 5, and 6 of J7.
- If separate audio and chassis grounds are not required, the chassis and audio ground pins of J7 may be interconnected for safety. Connect pin 1 to pin 3, pin 2 to pin 5, and pin 4 to pin 6.

Audio Level Settings

Summing Amplifier

To **adjust the trim of the summing amplifier**, do the following:

1. Activate all **audio devices connected to the MDA-100**.
2. While monitoring the summing amp output, adjust the **input level trimmers** on the front panel of the MDA-100, as required to equalize the summing amplifier input levels.

Distribution Amplifier

To **adjust the distribution amplifier**, do the following:

- > Adjust the **output level trimmers** on the front panel of the MDA-100, as required to supply a satisfactory signal level at each output destination.