

INSTALLATION INSTRUCTIONS

KP98-7 KEYPANEL VERSION 8.2

WITH EKP98-0 EXPANSION PANEL AND LCP-100A LEVEL CONTROL PANEL

ADAM™, ADAM™ CS, AND ZEUS™ INTERCOM SYSTEMS

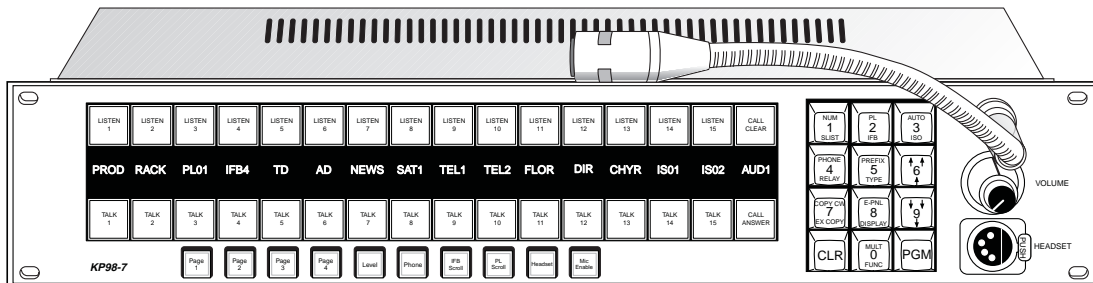

KP98-7

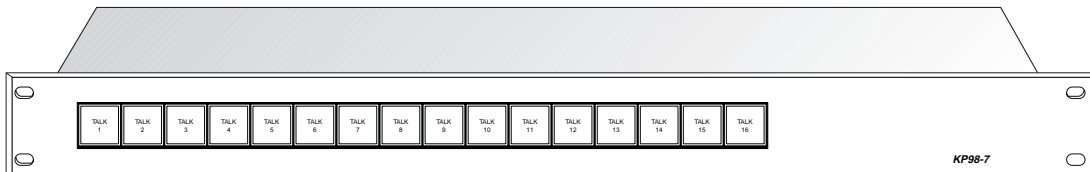

EKP98-0

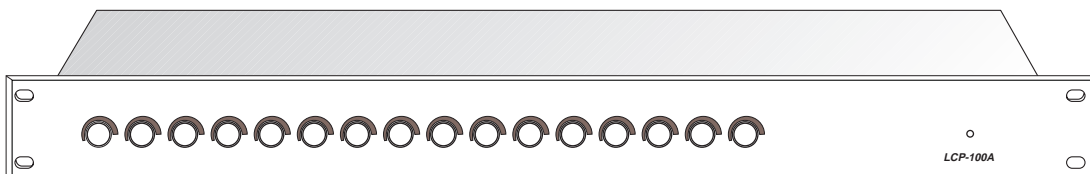

LCP-100A

RTS™

PROPRIETARY NOTICE

The RTS product information and design disclosed herein were originated by and are the property of Telex Communications, Inc. Telex reserves all patent, proprietary design, manufacturing, reproduction, use and sales rights thereto, and to any article disclosed therein, except to the extent rights are expressly granted to others.

COPYRIGHT NOTICE

Copyright 1997 by Telex Communications, Inc. All rights reserved. Reproduction in whole or in part without prior written permission from Telex is prohibited.

UNPACKING AND INSPECTION

Immediately upon receipt of the equipment, inspect the shipping container and the contents carefully for any discrepancies or damage. Should there be any, notify the freight company and the dealer at once.

WARRANTY INFORMATION

RTS products are warranted by Telex Communications, Inc. to be free from defects in materials and workmanship for a period of three years from the date of sale.

The sole obligation of Telex during the warranty period is to provide, without charge, parts and labor necessary to remedy covered defects appearing in products returned prepaid to Telex. This warranty does not cover any defect, malfunction or failure caused beyond the control of Telex, including unreasonable or negligent operation, abuse, accident, failure to follow instructions in the Service Manual or the User Manual, defective or improper associated equipment, attempts at modification and repair not authorized by Telex, and shipping damage. Products with their serial numbers removed or effaced are not covered by this warranty.

To obtain warranty service, follow the procedures entitled "Procedure For Returns" and "Shipping to Manufacturer for Repair or Adjustment".

This warranty is the sole and exclusive express warranty given with respect to RTS products. It is the responsibility of the user to determine before purchase that this product is suitable for the user's intended purpose.

ANY AND ALL IMPLIED WARRANTIES, INCLUDING THE IMPLIED WARRANTY OF MERCHANTABILITY ARE LIMITED TO THE DURATION OF THIS EXPRESS LIMITED WARRANTY.

NEITHER TELEX NOR THE DEALER WHO SELLS RTS PRODUCTS IS LIABLE FOR INCIDENTAL OR CONSEQUENTIAL DAMAGES OF ANY KIND.

CUSTOMER SUPPORT

Technical questions should be directed to:

Customer Service Department
RTS/Telex,
2550 Hollywood Way, Suite 207
Burbank, CA 91505 U.S.A.
Telephone: (818) 566-6700
Fax: (818) 843-7953

RETURN SHIPPING INSTRUCTIONS

PROCEDURE FOR RETURNS

If a repair is necessary, contact the dealer where this unit was purchased.

If repair through the dealer is not possible, obtain a RETURN AUTHORIZATION from:

Customer Service Department
Telex Communications, Inc.
Telephone: (800) 828-6107
Fax: (800) 323-0498

DO NOT RETURN ANY EQUIPMENT DIRECTLY TO THE FACTORY WITHOUT FIRST OBTAINING A RETURN AUTHORIZATION.

Be prepared to provide the company name, address, phone number, a person to contact regarding the repair, the type and quantity of equipment, a description of the problem and the serial number(s).

SHIPPING TO MANUFACTURER FOR REPAIR OR ADJUSTMENT

All shipments of RTS products should be made via United Parcel Service or the best available shipper, prepaid. The equipment should be shipped in the original packing carton; if that is not available, use any suitable container that is rigid and of adequate size. If a substitute container is used, the equipment should be wrapped in paper and surrounded with at least four inches of excelsior or similar shock-absorbing material. All shipments must be sent to the following address and must include the Return Authorization.

Factory Service Department
Telex Communications, Incorporated
8601 E. Cornhusker Hwy
Lincoln, NE 68505 U.S.A.

Upon completion of any repair the equipment will be returned via United Parcel Service or specified shipper collect.

End-User License Agreement for Telex® Software

IMPORTANT - Please read this document carefully before using this product.

THIS DOCUMENT STATES THE TERMS AND CONDITIONS UPON WHICH TELEX COMMUNICATIONS, INC. (the "COMPANY") OFFERS TO LICENSE THE INSTALLED SOFTWARE OR PROGRAM ("the SOFTWARE") FOR USE WITH THE PRODUCT IN WHICH IT WAS INSTALLED. YOU ARE AGREEING TO BECOME BOUND BY THE TERMS OF THIS AGREEMENT. IF YOU DO NOT AGREE TO THE TERMS OF THIS AGREEMENT, DO NOT USE THIS PRODUCT. PROMPTLY RETURN THE PRODUCT TO THE PLACE WHERE YOU OBTAINED IT FOR A FULL REFUND.

The installed software as supplied by the Company is licensed, not sold, to you for use only under the terms of this license, and the Company reserves all rights not expressly granted to you. You own the product or other media on or in which the Software is originally or subsequently recorded or fixed, but the Company retains ownership of all copies of the Software itself.

1. License: This license allows you to use the Software for internal purposes only on a single product in which it was installed.

2. Restrictions: (a) You may not market, distribute or transfer copies of the Software to others or electronically transfer or duplicate the Software. YOU MAY NOT REVERSE ENGINEER, DECOMPILE, DISASSEMBLE, MODIFY, ADAPT, TRANSLATE, RENT, LEASE OR LOAN THE SOFTWARE OR CREATE DERIVATIVE WORKS BASED ON THE SOFTWARE OR ANY ACCOMPANYING WRITTEN MATERIALS. (b) The Software and the accompanying written materials are copyrighted. Unauthorized copying of the Software, including portions thereof or the written materials, is expressly forbidden. (c) You understand that the Company may update or revise the Software and in so doing incurs no obligation to furnish such updates to you.

3. Limited Warranty: The Company does not warrant that the operation of the Software will meet your requirements or operate free from error. The Company DISCLAIMS ALL OTHER WARRANTIES AND CONDITIONS EITHER EXPRESS OR IMPLIED, INCLUDING THE WARRANTIES OF MERCHANTABILITY, FITNESS FOR A PARTICULAR PURPOSE AND NON-INFRINGEMENT OF THIRD PARTY RIGHTS.

4. Limited Liability: The liability of the Company for any claims arising out of this License based upon the Software, regardless of the form of action, shall not exceed the greater of the license fee for the Software or \$50.

This page intentionally left blank.

TABLE OF CONTENTS

INTRODUCTION	7
NEW FEATURES FOR VERSION 8.2	7
INSTALLATION	8
GENERAL	8
UNPACKING AND INSPECTION	9
CHECKING THE FACTORY JUMPER AND LEVEL SETTINGS	9
DIP SWITCH SETTINGS	9
Talk Key Row Selection	9
Expansion Panel In-use Indication for IFB and ISO	9
LCP Selection	9
Logical Keypanel Address Selection	9
Baud Rate	10
MOUNTING THE KEYPANEL AND ACCESSORIES	10
STANDARD CONNECTIONS	10
Gooseneck Microphone	10
Front Panel Headset	10
Connection To Intercom Matrix	10
OPTIONAL CONNECTIONS	11
EKP98-0 and LCP-100A	11
Rear Panel Headset Connection	13
Terminal Block Connections	13
EXT MIC IN Connector	13
EXT LINE IN Connector	13
MIC PRE OUT Connector	13
POWER-UP AND OPERATIONAL CHECK	14
KEYPANEL PROGRAMMING	14
ELECTRICAL ADJUSTMENTS	14
INTERNAL JUMPERS	14
J201 (EXTERNAL INPUT MUTING)	14
J202 (SPEAKER/HDST MUTE)	14
J203 (SIDETONE MUTING)	16
J401 (OUTPUT ENABLE)	16
J402 (BALANCE TEST)	16
J403 (PREAMP OUT)	16

J404-J406 (PANEL MIC SELECTION)	16
AUDIO LEVEL ADJUSTMENTS	16
GENERAL	16
MICROPHONE PREAMPLIFIER	16
SPEAKER/HEADSET AMPLIFIER ADJUSTMENTS	18

LIST OF FIGURES

Figure 1. KP98-7 Reference View	7
Figure 2. EKP98-0 Reference View	8
Figure 3. LCP-100A Reference View	8
Figure 4. 9-pin Intercom cable wiring diagram	11
Figure 5. RJ-11 Intercom cable wiring diagram	11
Figure 6. Typical Interconnections between the KP98-7, EKP98-0, and LCP-100A	12
Figure 7. Terminal block wiring diagram for KP-96-RC option	12
Figure 8. Locations of internal jumpers and trimmers	15

LIST OF TABLES

Table 1. DIP Switch Summary	9
Table 2. 9-pin FRAME Connector Pin-out	11
Table 3. RJ-11 FRAME Connector Pin-out	11
Table 4. EXT MIC IN Connector Pin-out	13
Table 5. EXT LINE IN Connector Pin-out	13
Table 6. Rear Panel Headset Connector Pin-out	13
Table 7. MIC PRE OUT Connector Pin-out	13
Table 8. Correspondence between address numbers and intercom port numbers for ADAM Intercom Systems	20

1 INTRODUCTION

This manual describes the installation of the KP98-7 Keypanel and its accessories, the EKP98-7 Expansion Panel and the LCP-100A Level Control Panel. The manual is based on version 8.2 of the keypanel firmware. For operating information, refer to the KP98-7 Operating Instructions Manual, version 8.2.

1.1 NEW FEATURES FOR VERSION 8.2

Version 8.2 adds support for the LCP-100A Level Control Panel. Version 8.2 also changes the positions of some of the function buttons at the bottom of the front panel and replaces the P-P function button with a Mic Enable function button. Note: usage of some of the DIP switches has also changed.

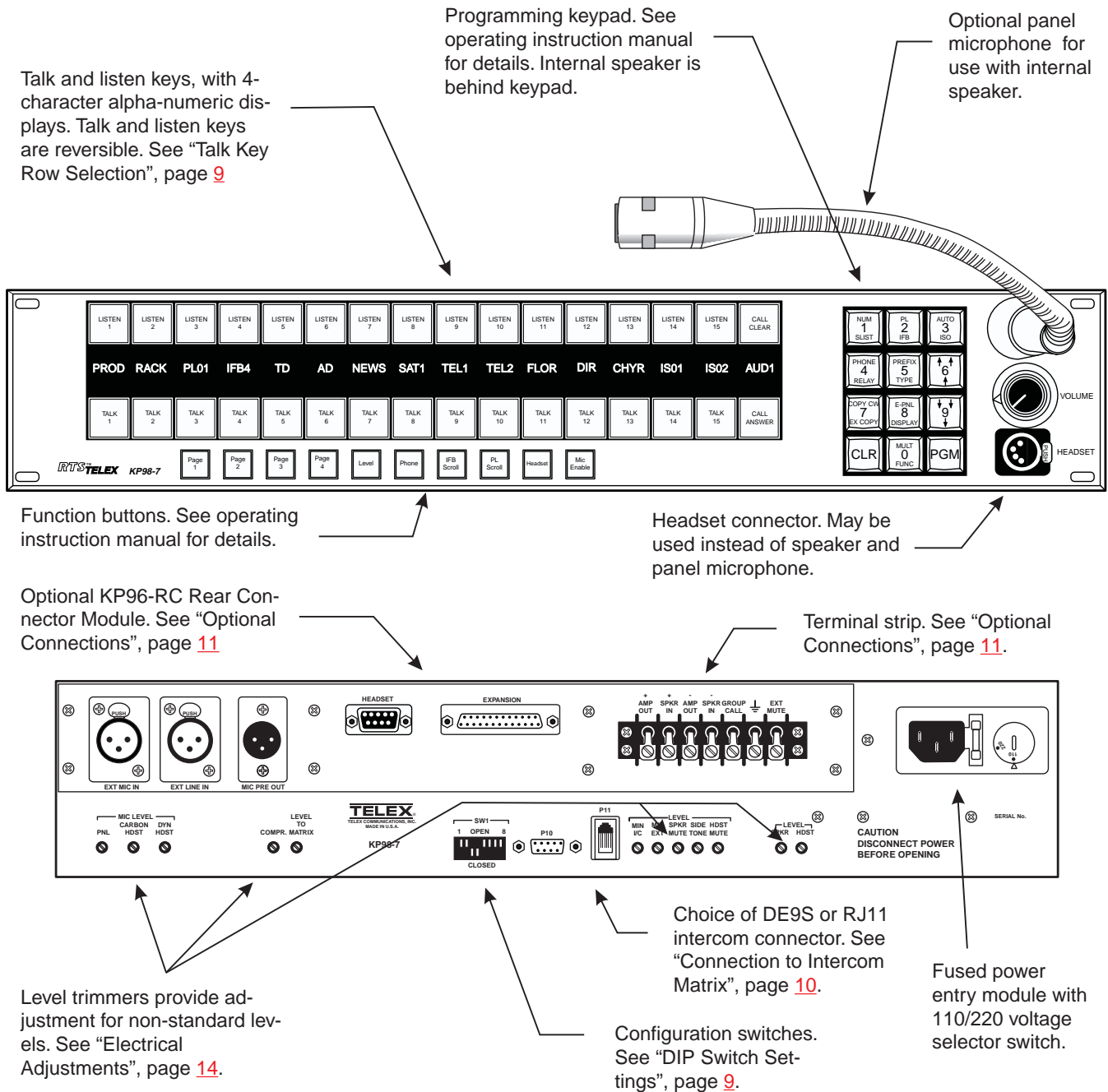

Figure 1. KP98-7 Reference View

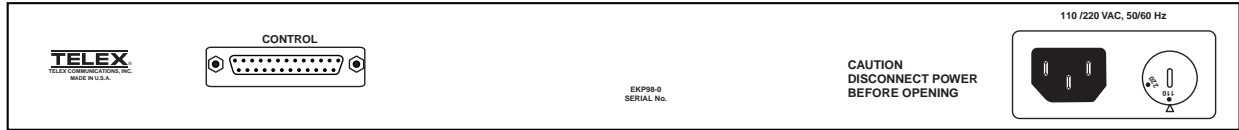
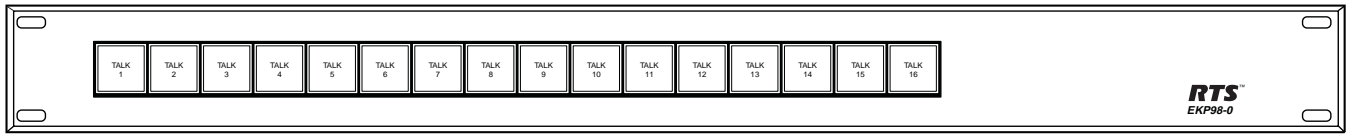

Figure 2. EKP98-0 Reference View

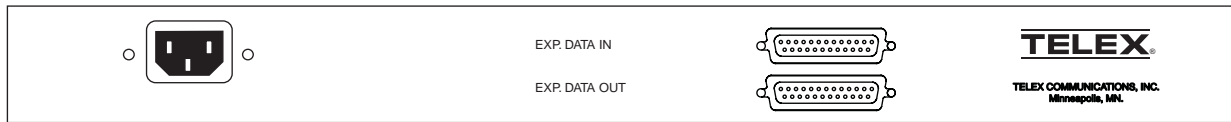
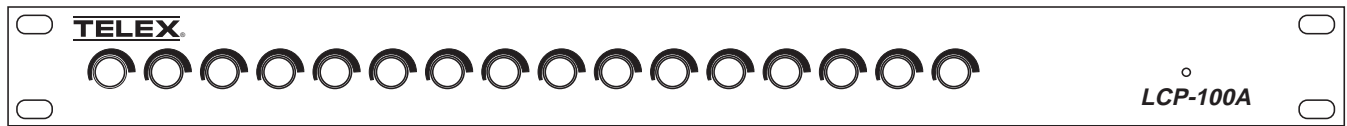

Figure 3. LCP-100A Reference View

2 INSTALLATION

2.1 GENERAL

Installation consists of the following general steps:

1. Unpack and inspect the equipment.
2. Check that the factory default jumper positions and level settings are appropriate for your application and make any required changes. (The defaults are virtually always acceptable.)
3. Set the back panel DIP switches.
4. Mount the keypanel and any accessories in an equipment rack or bay.
5. Connect the keypanel and any accessories.
6. Power up the equipment and check operation.
7. Program the keypanel using the intercom system configuration software (ADAMedit or ZEUSedit). Some aspects of keypanel setup, such as key assignment, may also be performed from the keypanel using the programming keypad. Refer to the “Advanced Operation” information in the KP98-7 Operating Instructions Manual.
8. Place the keypanel in service. If the keypanel keys have been assigned prior to placing the keypanel in service, the station operator should only need to refer to the “Basic Operation” information in the KP98-7 Operating Instructions Manual.

2.2 UNPACKING AND INSPECTION

As soon as possible after receipt, inspect the container(s) and contents for physical damage that may have occurred in shipping. If damage has occurred, immediately (within 24 hours of receipt of equipment) contact the carrier involved and file a claim. Save all packing materials, and request an immediate inspection by the carrier's insurance claims agent.

There should be one power cord for each KP98-7 and one gooseneck microphone for each KP98-7 ordered with a microphone. There should be one power cord and one interconnect cable for each EKP98-0 Expansion Panel and LCP-100A Level Control Panel.

☞ For information about returns to RTS, refer to the front of this manual.

2.3 CHECKING THE FACTORY JUMPER AND LEVEL SETTINGS

There are several internal jumpers and level adjustments which can be changed to modify the keypanel operation and audio input/output levels. These have been set to meet the requirements of most typical situations. However, if you wish to review these settings prior to installation, refer to "Electrical Adjustments", page 14.

2.4 DIP SWITCH SETTINGS

The DIP switches are located on the back of the KP98-7 keypanel. The switch settings are summarized in Table 1 and are described in the following paragraphs.

☞ **Important:** Any time you change the DIP switch settings you must turn the power off-then-on to reset.

2.4.1 Talk Key Row Selection

You can select whether you want the talk keys to use the top row (above the displays) or the bottom row. See DIP switch 1 settings.

2.4.2 Expansion Panel In-use Indication for IFB and ISO

The KP98-7 provides a flashing display indication when an IFB or ISO is in-use by another keypanel. Generally, the keypanel operator can distinguish this from an incoming call for two reasons: first, the flashing indication is slower than an incoming call indication; second, an IFB or ISO will generally have a distinctive name, and since calls are not normally received from an IFB or ISO, the

Table 1. DIP Switch Summary

DIP Switch	Description	Settings				
1	Talk key row select	Open: Use bottom row Closed: Use top row				
2	Expansion Panel In-use Indication	Open: Flash Closed: No flash				
3	LCP select	Open: No LCP connected Closed: LCP connected				
		Address	Sw 4	Sw 5	Sw 6	Sw 7
4	Logical keypanel address select.	1	Close	Open	Open	Open
		2	Open	Close	Open	Open
5		3	Close	Close	Open	Open
		4	Open	Open	Close	Open
6		5	Close	Open	Close	Open
		6	Open	Close	Close	Open
7		7	Close	Close	Close	Open
		8	Open	Open	Open	Close
8	Baud rate select	Open: 9600 baud Closed: 76.8 kbaud (DO NOT USE!)				

keypanel operator is able to conclude that the flashing indication is not an incoming call.

EKP98-0 expansion panels connected to the KP98-7 are a different matter, however, since they use illuminated buttons without alphanumeric displays and cannot display names. In this case the keypanel operator can only distinguish between an in-use indication and an incoming call indication by the speed of the button flash. If this creates confusion, disable the flashing in-use indication by setting DIP switch 2 to the "closed" position.

2.4.3 LCP Selection

If a level control panel will be connected for use with the KP98-7, set DIP switch 3 to the "Closed" position. Otherwise, leave this switch in the "Open" position.

2.4.4 Logical Keypanel Address Selection

DIP switches 4-7 set the logical keypanel address, which uniquely identifies the keypanel in the intercom system.

Zeus Intercom Systems: The logical keypanel addresses are the numbers 1 through 8 printed on the back panel of the Zeus frame next to the keypanel connectors. (The numbers repeat for every group of 8 connectors.) As you connect each keypanel to a connector, use the number printed next to that connector to set the address. For example, if you connect a keypanel to a connector numbered 1, refer to Table 1 and set DIP switches 4 through 7 to select address 1.

ADAM CS Intercom Systems: Use the appropriate planning worksheet in the ADAM CS Installation Manual. (Refer to the List of Tables in the front of the manual. The planning worksheets are listed at the bottom of the List of Tables.)

- **ADAM CS with RJ-11 or DB-9 back panel:** You can determine the correct logical keypanel address from the worksheet in either of two ways: 1) If you know the port number that a keypanel will be connected to, look up the port number in the worksheet, then read across to the appropriate logical keypanel number for that port number. 2) If you know the connector number (on the back of the ADAM CS frame) that the keypanel will be connected to, look up that connector number in the worksheet, then read across to the appropriate logical keypanel number.

Once you have determined the correct logical keypanel number, refer to Table 1 and position DIP switches 4 through 7 to set this as the address.

- **ADAM CS frame with 50-pin Telco back panel:** You can determine the correct logical keypanel address from the worksheet in either of two ways: 1) If you know the port number that a keypanel will be connected to, look up the port number in the worksheet, then read across to the appropriate logical keypanel number for that port number. 2) If you know the connector numbers and pin numbers that the keypanel will be connected to, look up these numbers in the worksheet, then read across to the appropriate logical keypanel number.

Once you have determined the correct logical keypanel number, refer to Table 1 and position DIP switches 4 through 7 to set this as the address.

ADAM Intercom Systems: To set the address, first refer to Table 8, page 20, and locate the intercom port number to which the keypanel will be connected. Then, read across to the “Address” column to find the logical keypanel address (it will always be a number between 1 and 8). Finally, refer to Table 1 and set the DIP switches to this address number.

2.4.5 Baud Rate

SW1-8 selects the baud rate for communication with the intercom system’s configuration computer. For all ADAM, ADAM CS, and Zeus intercom systems this switch must be set to the open position (9600 baud). Do not use the 76.8 kbaud setting.

2.5 MOUNTING THE KEYPANEL AND ACCESSORIES

Keypanels, expansion panels and level control panels may be mounted in any industry standard 483 mm (19”) wide equipment rack or equipment bay. For all panels, allow an additional 2 to 3 inches in back for cables and connectors. No special tools other than those found in a typical tool kit are required for mounting. The panels have no special ventilation requirements.

For ease of use, when positioning the panels it may help to locate each level control panel directly above or below the keypanel or expansion panel that it will be used with. Otherwise, you will have to label each LCP control knob according to the key assignment alphas on the keypanel or expansion panel.

2.6 STANDARD CONNECTIONS

2.6.1 Gooseneck Microphone

If you ordered the KP98-7 with a gooseneck microphone, screw the microphone into the panel microphone jack on the front panel.

2.6.2 Front Panel Headset

The front panel headset jack accepts a monaural, dynamic-microphone headset. Headphone impedance should be 8 to 400 ohms. Nominal microphone output should be -60 dBm, 150 ohms.

Connector Type: D4F (Mates with A4M)

Pin 1: Microphone -
Pin 2: Microphone +
Pin 3: Headphone -
Pin 4: Headphone +

2.6.3 Connection To Intercom Matrix

Use either a 9-pin or RJ-11 intercom cable (but not both) to connect to the intercom system. You can use a prefabricated cable, or construct a cable using the wiring diagram in Figure 4 or 5. Plug one end of the cable into the P10 or P11 connector on the back panel of the KP98-7. Plug the other end into the appropriate port of the intercom system. (This will be the port number that you designated previously when setting the address DIP switches.)

☞ Keypanels may be connected while the intercom system is running.

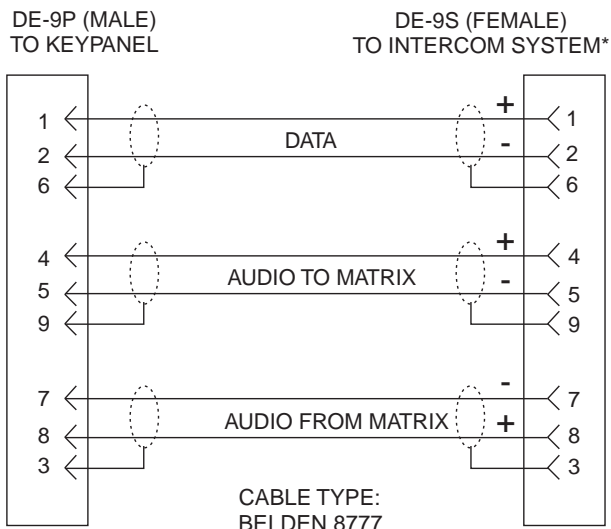

IMPORTANT!

* When connecting to an ADAM CS back panel, use only low-profile cable connectors such as AMP Part No. 747516-3 (Telex Part No. 59926-678)

Figure 4. 9-pin Intercom cable wiring diagram

Table 2. 9-pin FRAME Connector Pin-out

Pin	Function
1	RS422 Data "+"
2	RS 422 Data "-"
3	Ground , Shield
4	Audio Output "+"
5	Audio Output "-"
6	Ground, Shield
7	Audio Input "-"
8	Audio Input "+"
9	Ground

☞ Note that 9-pin intercom cables for use with an ADAM CS frame must use special connectors at the intercom matrix end as shown in Figure 4.

2.7 OPTIONAL CONNECTIONS

☞ The following connections require an optional KP96-RC Rear Connector Panel on the back of the KP98-7 Keypanel.

2.7.1 EKP98-0 and LCP-100A

Figure 6 shows optional connections when using an Expansion Panel and/or Level Control Panel with the KP98-7. Use the cables supplied with the panels. A maxi-

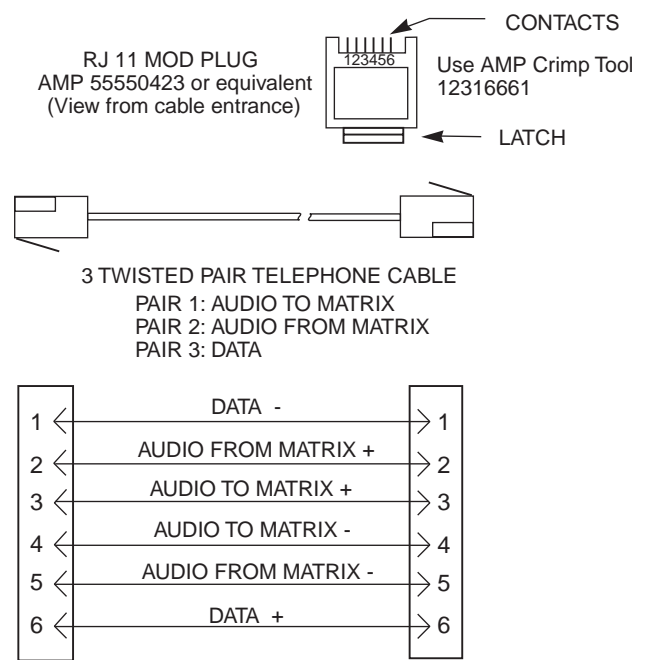

Figure 5. RJ-11 Intercom cable wiring diagram

Table 3. RJ-11 FRAME Connector Pin-out

Pin	Function
1	RS422 Data "-"
2	Audio Input "+"
3	Audio Output "+"
4	Audio Output "-"
5	Audio Input "-"
6	RS422 Data "+"

imum of one EKP98-0 and one LCP-100A may be connected. The LCP-100A can only be used to adjust levels for the KP98-7. To adjust listen levels for keys on the EKP98-0, use the Crosspoint Gain feature of ADAMedit or Zeus-edit.

☞ To use the Crosspoint Gain feature with a key on the EKP98-0, you will first have to assign one of the special functions to the key. To do this, run ADAMedit or Zeus-edit. Press the KP button on the toolbar at the bottom of the screen to open the "Keypanels / Ports" edit screen. Right-click on the box next to the listen key that you want to assign. A dialog window titled "Key Assignment Select" will open. Select "Special Function" and click ok. Select "AL", "AM", or "AR". "AL" assigns auto-listen; listen will automatically activate whenever the talk

KP98-7 Keypanel with LCP-100A Level Control Panel Only

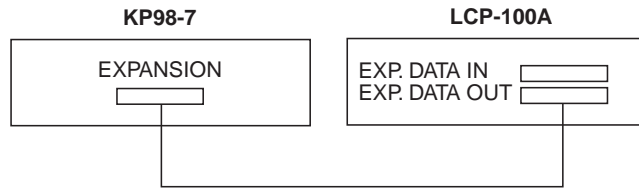

KP98-7 Keypanel with EKP98-0 Expansion Panel Only

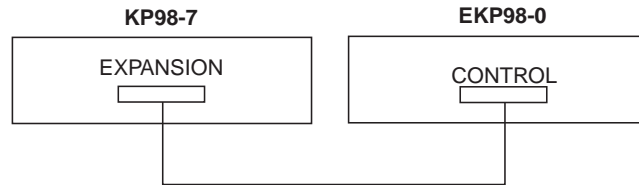

**KP98-7 Keypanel with LCP-100A Level Control Panel and EKP98-0 Expansion Panel
(The LCP-100A adjusts levels only for the KP98-7 Keypanel.)**

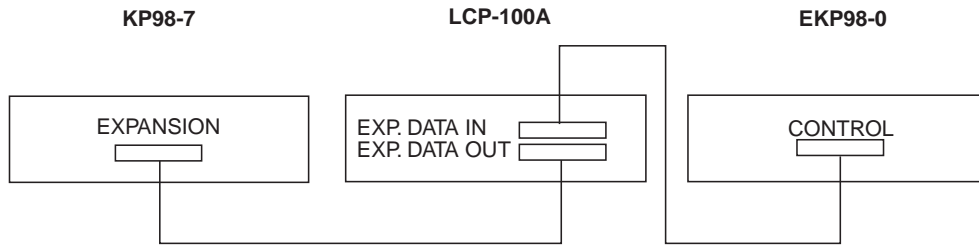

Figure 6. Typical Interconnections between the KP98-7, EKP98-0, and LCP-100A

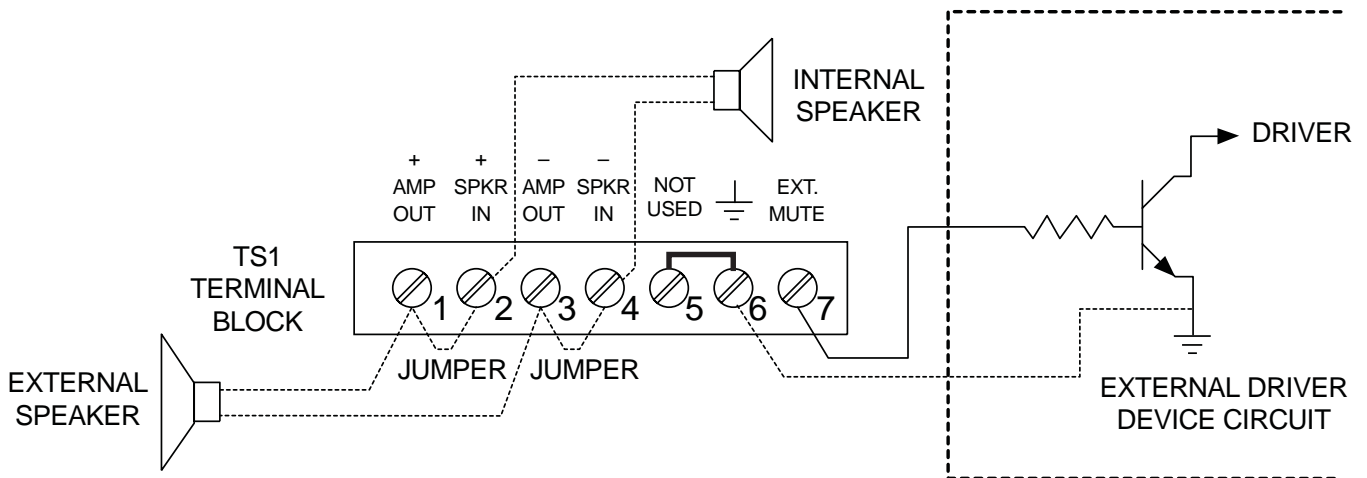

Figure 7. Terminal block wiring diagram for KP-96-RC option

key is activated. “AM” assigns auto-mute; listen will be on when the key is off and will automatically mute when the key is turned on. “AR” assigns auto-reciprocal; listen will remain on all the time. Once you’ve selected one of these options, you can then adjust the crosspoint gain. Click the Gain button on the toolbar, select Crosspoint Gains and click OK, then press the F1 key on the computer keyboard to get help with this feature if desired.

2.7.2 Rear Panel Headset Connection

Table 6 lists the HEADSET connector pin functions. A variety of headset types can be connected. Headset/speaker switching can also be accomplished from this connector. When the front panel HDST switch is in the off position, shorting pins 7 and 8 on the rear panel headset connector will cause the headset to activate, and the front panel speaker and microphone will turn off.

Table 6. Rear Panel Headset Connector Pin-out

Pin	Function
1	Dynamic mic “+” input
2	Dynamic mic common (shield)
3	Carbon mic “+” input
4	Carbon mic common
5	Headphone “+”
6	Dynamic mic “-” input
7	HDST switch control
8	HDST switch common
9	Headphone common

2.7.3 Terminal Block Connections

(Reference Figure 7)

AMP OUT + and - : These terminals provide the key-panel audio amplifier output signal to drive an 8-ohm, 3-watt speaker. As supplied from the factory, jumpers connect these terminals to the SPKR IN + and - terminals. Remove these jumpers only if the keypanel audio output is to be redirected to an external speaker.

SPKR IN + and - : These terminals connect to the internal speaker.

EXT MUTE: This terminal may be used to drive an external device at no greater than 2 mA sinking current. Its normal logic state is low (0 Vdc). It shifts to logic high (+5Vdc) when any Talk key is pressed. This signal may be used, for example, to mute a monitor speaker when the keypanel operator is talking on the intercom system.

2.7.4 EXT MIC IN Connector

An external microphone can be connected. The external microphone may be used with or without a front panel gooseneck microphone of the same type. (Internal key-panel jumpers J404-J406 must be set for the type of microphone (see “Internal Jumpers”, page 14).

Table 4. EXT MIC IN Connector Pin-out

Pin	Function
1	Shield
2	Mic in “+”
3	Mic in “-”

2.7.5 EXT LINE IN Connector

An external balanced audio source, such as program sound, can be connected. The input is calibrated for a nominal line level of +8dBu. This level can be changed if required. See “Line Input to Speaker Level Adjustment”, page 18, for further information.

Table 5. EXT LINE IN Connector Pin-out

Pin	Function
1	Shield
2	Line in “+”
3	Line in “-”

2.7.6 MIC PRE OUT Connector

This connector provides a balanced mic output signal of +8 dBu at 60 ohms. As supplied, the MIC PRE OUT signal is activated only when any Talk key is on. If you want this output to be on continuously, you must reset internal jumper J403 (see “Internal Jumpers”, page 14).

Table 7. MIC PRE OUT Connector Pin-out

Pin	Function
1	Shield
2	Mic out “+”
3	Mic out “-”

2.8 POWER-UP AND OPERATIONAL CHECK

Plug in the ac power cords on the keypanel and any connected expansion panels. When power is applied, all alphanumeric displays will first display asterisks (****) then dashes (----). After a few moments, the Talk key assignments will display. If no Talk key assignments have yet been programmed, the displays will continue to show dashes (----).

If the keypanel cannot establish data communications with the intercom system, the alphanumeric displays will continue to show asterisks (****). Check the data line connections.

Several symptoms may occur if the logical keypanel number is incorrectly set: 1) the keypanel may not display the expected key assignments; 2) there may be no indication when there is an incoming call; 3) when a key is pressed to talk, the destination may not hear the audio, or may hear audio from a different intercom station; 4) the displays may behave erratically. If any of these symptoms occur, recheck the logical keypanel number DIP switches.

 **Important!** Always reset the keypanel after changing the DIP switch settings. Do this by briefly removing power to the keypanel.

2.9 KEYPANEL PROGRAMMING

If you previously configured the keypanel using the intercom system configuration software, it should be ready for operation. Refer the station operator to the “Basic Operation” instructions in the KP98-7 Operating Instructions Manual.

If the keypanel has not yet been configured you can do so now. Run the ADAMedit or Zeus-edit configuration software. By default, the configuration software starts up in the “Keypanels / Ports” setup screen. For assistance with keypanel setup, press the F1 key on the computer while viewing that screen. Once you have configured the keypanel as instructed and sent the changes to the intercom system, the keypanel should be ready for operation. Refer the station operator to the “Basic Operation” instructions in the KP98-7 Operating Instructions Manual.

This completes the standard installation procedures.

3 ELECTRICAL ADJUSTMENTS

3.1 INTERNAL JUMPERS

There are several internal jumpers which modify keypanel operation. The jumpers are set for the following default operations:

J201: The EXT LINE IN signal (KP-96-RC option only) is muted when any Talk key is pressed. May be optionally set for no mute.

J202: The speaker (or headphones) are muted by 15 dB when any Talk key is pressed. May be optionally set to full mute.

J203: Continuous sidetone. When using a headset, the keypanel operators own voice will be heard at all times in the headphones. May be optionally set for sidetone only during talk.

J401: The microphone activates when any Talk key is pressed. May be optionally set for continuous microphone.

J402: Normal/test switch set for normal operation.

J403: The MIC PRE OUT signal (KP-96-RC option only) is activated only when any Talk key is pressed. May be optionally set for continuous operation.

J404-J406: The keypanel is configured for operation with the standard dynamic, -70dB, 150-ohm gooseneck microphone. May be optionally configured for other microphone types.

To reset any of the jumpers, remove the top cover from the keypanel. Locations of the jumpers are shown in Figure 8. The following paragraphs describe the alternative settings for the jumpers.

3.1.1 J201 (EXTERNAL INPUT MUTING)

This jumper is only significant in keypanels that have the KP-96-RC Rear Connector Plate option installed. When pins 2 and 3 are shorted, a signal input at the EXT LINE IN connector is muted when any Talk key is pressed. When pins 1 and 2 are shorted, the signal is not muted during Talk key activation.

3.1.2 J202 (SPEAKER/HDST MUTE)

When pins 1 and 2 are shorted, the speaker/headset signal is fully muted when any Talk keys are pressed. When pins

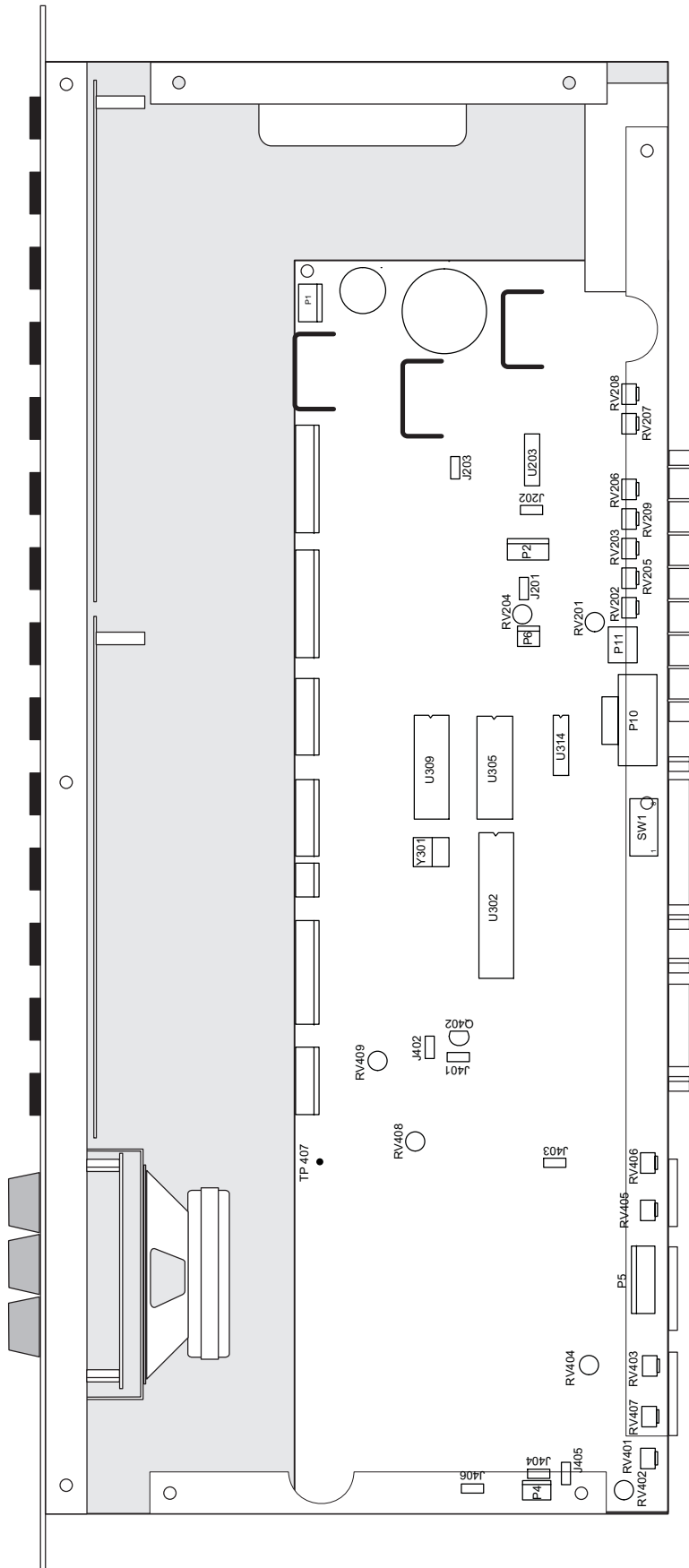

Figure 8. Locations of internal jumpers and trimmers

2 and 3 are shorted, the signal is muted by 15 dB when any Talk keys are pressed.

3.1.3 J203 (SIDETONE MUTING)

When pins 1 and 2 are shorted, the sidetone signal is always on. When pins 2 and 3 are shorted, the sidetone signal is on only when a Talk key is pressed.

3.1.4 J401 (OUTPUT ENABLE)

When the jumper is installed, the microphone is on only when any Talk key is pressed. When the jumper is removed, the microphone will always be on.

3.1.5 J402 (BALANCE TEST)

For normal operation, there should be no jumper installed. This jumper is used when adjusting the keypanel audio levels. See "Balance Adjustment", page [17](#).

3.1.6 J403 (PREAMP OUT)

This jumper is only significant in keypanels that have the KP-96-RC Rear Connector Plate option installed. When pins 1 and 2 are shorted, the mic signal at the MIC PRE OUT connector is switched on and off by the Talk keys. When pins 2 and 3 are shorted, the mic signal at the MIC PRE OUT connector is always on.

3.1.7 J404-J406 (PANEL MIC SELECTION)

These jumpers work together to configure the panel microphone preamp for various types of microphones as follows:

2-Wire Electret:

- J404 Pins 1 and 2 shorted
- J405 No jumper
- J406 No jumper

3-Wire Electret:

- J404 No jumper
- J405 No jumper
- J406 No jumper

Balanced Dynamic (-70 dB, 150 ohms):

- J404 Pins 2 and 3 shorted
- J405 Pins 1 and 2 shorted
- J406 Pins 1 and 2 shorted

3.2 AUDIO LEVEL ADJUSTMENTS

3.2.1 GENERAL

The following paragraphs describe the procedures to calibrate the output level to the factory standard of +8 dBu. If a different level is required, substitute that level for +8 dBu.

Most audio level trimmers are accessible through access holes on the back of the keypanel. Each trimmer access hole is labeled with its function. Some trimmers are internal, and can only be accessed with the top cover removed. Locations of trimmers are shown in Figure [8](#).

Audio levels may be adjusted with the panel disconnected from the intercom system. However, proper operation should be confirmed when the panel is reconnected. If levels change after reconnection, check the intercom system wiring for one-sided shorts to ground, wiring errors, or unintended terminations.

The following procedures make use of the additional connectors available on the KP-96-RC Rear Connector Plate option. Connector pin-outs for these connectors were presented earlier in this section. If the keypanel under adjustment does not have these connectors, refer to drawing number IKP-950/2-5 (in the Keypanel Drawings and Parts Manual). The IKP-950/2-5 drawing shows equivalent locations where test equipment may be connected.

Required test equipment:

Audio Signal Generator with balanced output

Audio Signal Analyzer with balanced input

DC Millivoltmeter

Oscilloscope - any commercially available type

3.2.2 MICROPHONE PREAMPLIFIER

1. Set the HDST switch to off.
2. Remove the gooseneck microphone, and insert a -70 dBm signal (1KHz at 150 ohms) into the microphone connector. Or use the EXT MIC IN connector with the front panel microphone removed (ref Table [4](#), page [13](#) for pin-out).
3. Activate the microphone by setting a Talk key to the latched-up position.

4. Check the level at the MIC PRE OUT connector (ref Table 7 for pin-out). It should measure +8 dBu.
5. If the reading is not +8 dBu, but within a 3dB range, adjust the LEVEL TO MATRIX trimmer (RV406) for +8dBu.
6. If the reading is more than 3 dB from +8 dBu, or another output level is used by your facility, proceed to paragraph to begin the mic preamp calibration procedures.
7. Check the frequency response from 200 Hz to 15 KHz. It should be within 1 dB.
8. Check the input noise. It should be at least -70 dB below +8 dBu.
9. Check the Total Harmonic Distortion (THD) from 200 Hz to 15KHz at +18 dBu output. It should be less than or equal to 0.15 percent.

Balance Adjustment

1. Turn the COMPR trimmer (RV405) fully counterclockwise. This sets the compressor circuit to minimum (compressor ratio of 1:1).
2. Measure and record the dc voltage at test point TP407.
3. Install a shorting plug across J402.
4. Measure the dc voltage at TP407, and adjust RV408 (internal) to match (within 5 mV) the previously recorded voltage.
5. Remove the shorting plug at J402.

Tone Generator Level Adjustment

1. Activate the 400 Hz tone generator in the keypad (enter 0-8-7 on the keypad).
2. Adjust the LEVEL TO MATRIX trimmer (RV406) for a +8dBu tone output level at the MIC PRE OUT connector.
3. Turn off the tone generator (press CLR on the keypad).

Panel Mic Level Adjustment

1. Configure the J404-J406 jumper blocks for a balanced dynamic panel microphone: J404 short pins

2-3; J405 short pins 1-2; J406 short pins 1-2. (This is the default microphone configuration.)

2. Insert a -70dBm signal (1 KHz at 150 ohms) into the gooseneck microphone connector. Or use the EXT MIC IN connector (with the front panel microphone removed).
3. Adjust the PNL trimmer (RV401) for +8dBu at the MIC PRE OUT connector.
4. Insert a common mode signal (120 Hz, -70 dBm) into the gooseneck microphone connector, or into the EXT MIC IN connector.
5. Adjust RV402 (internal) for a minimum common mode signal at the MIC PRE OUT connector.
6. Re-insert a -70dBm signal.
7. Remove the shorting plug across J401 (causes continuous mic activation).
8. Monitor the level at the audio output pins of the FRAME connector, P10 (reference Table - for pin-out). The output level should be +8dBu.
9. Remove the signal from the mic input, and reinstall the shorting plug across J401.

Headset Dynamic-Mic Level

1. Insert a -60dBm signal (1 KHz at 150 ohms) into the dynamic mic input of the HEADSET connector (reference Table 6, page 13 for pin-out).
2. Activate the HDST key on the front of the keypad.
3. Monitor the signal level at the MIC PRE OUT connector. It should be +8 dBu. If not, adjust the DYN HDST trimmer (RV403) to achieve an output reading of +8 dBu.
4. Insert a common mode signal into the dynamic mic input of the HEADSET connector.
5. Adjust RV404 (internal) for a minimum common mode signal at the MIC PRE OUT connector.
6. Remove the signal at the dynamic mic input.

Headset Carbon-Mic Level

1. Insert a -25dBm signal (1 KHz at 50 ohms) into the carbon mic input of the HEADSET connector (reference Table 6 for pin-out).

☞ A +12 vdc bias voltage is supplied at pin 3 (carbon mic + input) of the HEADSET connector. The signal generator should be isolated from this dc bias voltage.

2. Activate the HDST key on the front of the keypanel.
3. Monitor the signal level at the MIC PRE OUT connector. It should be +8 dBu. If not, adjust the CARBON HDST trimmer (RV407) to achieve an output reading of +8 dBu.
4. Remove the signal from the carbon mic input.

Compressor/AGC Setup

1. Insert a -60 dBm signal (1 KHz at 150 ohms) into the front panel microphone connector. Or use the EXT MIC IN connector (with the front panel microphone removed).
2. Adjust the COMPR trimmer (RV405) to measure +13dBu at the audio output of the FRAME connector, P10.
3. Reduce the input signal level to -80 dBm.
4. Adjust RV409 (internal) for a +4 dBu audio output level at the FRAME connector.
5. Perform this procedure several times to optimize the compression ratio accuracy. This will test compression at a 2:1 ratio (0.5dBu). Confirm correct operation of the compression circuit by increasing and reducing input levels and measuring output ratio accordingly.

3.2.3 SPEAKER/HEADSET AMPLIFIER ADJUSTMENTS

Matrix-to-Speaker Gain

1. Disconnect the loudspeaker (either internal or external) from the + AMP OUT and - AMP OUT terminals on the back of the keypanel.
2. Terminate the + AMP OUT and - AMP OUT terminals with an 8-ohm, 10-watt resistive load. Connect an audio analyzer across the load.

3. Remove the keypanel audio connection from the intercom matrix.
4. Insert a +8dBu (1 KHz) signal into the audio input + and - pins of the FRAME connector, P10 (Table 2, page 11).
5. Turn the front panel HDST switch off.
6. Turn the front panel intercom audio level control (outer knob) fully clockwise (maximum volume).
7. Adjust the SPKR trimmer (RV207) to measure 4.9VRMS (3 watts) at the audio analyzer. There should be no clipping of the output signal.
8. Turn the front panel intercom audio level control fully counterclockwise (minimum volume). Adjust the MIN I/C trimmer (RV202) to measure -30 dB below the 4.9VAC reference level.
9. Readjust the front panel intercom audio level control to again measure 4.9VAC at the audio analyzer.
10. Insert a 1 KHz common mode signal into the audio input + and - pins of the FRAME connector.
11. Adjust RV201 (internal) for a minimum common mode signal.
12. Remove the signal from the FRAME connector.

Line Input-to-Speaker Gain Adjustment

1. Install a shorting plug across J201, pins 2 and 3.
2. Insert a +8dBu (1 KHz) signal into the EXT LINE IN connector (reference Table 5, page 13, for pin-out).
3. The HDST switch should be off.
4. Turn the line input level control (inner knob on the front panel) fully counterclockwise.
5. Adjust the MIN EXT trimmer (RV205) to measure -30 dB below a reference level of 4.9VAC level at the audio analyzer connected to the amplifier output.
6. Readjust the line input level control to measure 4.9VAC output at the audio analyzer.
7. Insert a 1KHz common mode signal into the EXT LINE IN connector.

8. Adjust RV204 (internal) for a minimum common mode signal.
9. Insert a +8dBu (1 KHz) signal into the EXT LINE IN connector and record the output reading.
10. Remove the signal from the EXT LINE IN connector, and insert it into the audio input + and - pins of the FRAME connector, P10.
11. Remove the shorting plug from jumper block J201. The output reading should be the same as in step 9.

Speaker Muting Setup

1. Short pins 2 and 3 of jumper block J202.
2. Insert a +8dBu signal (1 KHz) into the audio input pins of the FRAME connector, P10.
3. Alternately activate and deactivate a front panel Talk key while adjusting the SPKR MUTE trimmer (RV203) to provide 15dB muting at the + AMP OUT and - AMP OUT terminals during Talk switch activation.
4. Short pins 1 and 2 of J202. Insert a +8dBu signal (1 KHz) into the audio input of the FRAME connector.
5. Activate a front panel Talk key, and check that the amplifier output is fully muted. Restore the J202 shorting plug to pins 2-3.
6. Remove the 8-ohm load from the amplifier output, and reconnect the speaker.

Headphone Level Adjust

1. Terminate the headphone output of the HEADSET connector (pins 5 and 9) with an 8-ohm, 10-watt resistive load. Connect an audio analyzer across the load.
2. Set the front panel HDST switch to on.
3. Insert a +8dBu signal (1 KHz) into the audio input of the FRAME connector.
4. Adjust the HDST trimmer (RV208) for 2VRMS (500 milliwatts) at the headphone output.
5. Set the front panel HDST switch to off.
6. Adjust the HDST MUTE trimmer (RV206) for 6dB muting below the 2V AC reference level.

Sidetone Level Adjust

1. Install a shorting plug across pins 1-2 of J203.
2. Insert a -70dBm signal (1KHz at 150 ohms) into the dynamic mic input of the HEADSET connector .
3. Turn on the HDST switch, and monitor the signal level across the 8-ohm load at the headphone output of the HEADSET connector.
4. Adjust the SIDETONE trimmer (RV209) to 35 dB below a 2V AC reference level. (The level may be varied according to user preference.)
5. Remove the test equipment.

Table 8. Correspondence between address numbers and intercom port numbers for ADAM Intercom Systems

Address	Intercom Port Numbers (8 Ports per Audio I/O Card)																								
	1	2	3	4	5	6	7	8	9	10	11	12	13	14	15	16	17	18	19	20	21	22	23	24	
1	1	9	17	25	33	41	49	57	65	73	81	89	97	105	113	121	129	137	145	153	161	169	177	185	193
2	2	10	18	26	34	42	50	58	66	74	82	90	98	106	114	122	130	138	146	154	162	170	178	186	194
3	3	11	19	27	35	43	51	59	67	75	83	91	99	107	115	123	131	139	147	155	163	171	179	187	195
4	4	12	20	28	36	44	52	60	68	76	84	92	100	108	116	124	132	140	148	156	164	172	180	188	196
5	5	13	21	29	37	45	53	61	69	77	85	93	101	109	117	125	133	141	149	157	165	173	181	189	197
6	6	14	22	30	38	46	54	62	70	78	86	94	102	110	118	126	134	142	150	158	166	174	182	190	198
7	7	15	23	31	39	47	55	63	71	79	87	95	103	111	119	127	135	143	151	159	167	175	183	191	199
8	8	16	24	32	40	48	56	64	72	80	88	96	104	112	120	128	136	144	152	160	168	176	184	192	200
1	201	209	217	225	233	241	249	257	265	273	281	289	297	305	313	321	329	337	345	353	361	369	377	385	393
2	202	210	218	226	234	242	250	258	266	274	282	290	298	306	314	322	330	338	346	354	362	370	378	386	394
3	203	211	219	227	235	243	251	259	267	275	283	291	299	307	315	323	331	339	347	355	363	371	379	387	395
4	204	212	220	228	236	244	252	260	268	276	284	292	300	308	316	324	332	340	348	356	364	372	380	388	396
5	205	213	221	229	237	245	253	261	269	277	285	293	301	309	317	325	333	341	349	357	365	373	381	389	397
6	206	214	222	230	238	246	254	262	270	278	286	294	302	310	318	326	334	342	350	358	366	374	382	390	398
7	207	215	223	231	239	247	255	263	271	279	287	295	303	311	319	327	335	343	351	359	367	375	383	391	399
8	208	216	224	232	240	248	256	264	272	280	288	296	304	312	320	328	336	344	352	360	368	376	384	392	400
1	401	409	417	425	433	441	449	457	465	473	481	489	497	505	513	521	529	537	545	553	561	569	577	585	593
2	402	410	418	426	434	442	450	458	466	474	482	490	498	506	514	522	530	538	546	554	562	570	578	586	594
3	403	411	419	427	435	443	451	459	467	475	483	491	499	507	515	523	531	539	547	555	563	571	579	587	595
4	404	412	420	428	436	444	452	460	468	476	484	492	500	508	516	524	532	540	548	556	564	572	580	588	596
5	405	413	421	429	437	445	453	461	469	477	485	493	501	509	517	525	533	541	549	557	565	573	581	589	597
6	406	414	422	430	438	446	454	462	470	478	486	494	502	510	518	526	534	542	550	558	566	574	582	590	598
7	407	415	423	431	439	447	455	463	471	479	487	495	503	511	519	527	535	543	551	559	567	575	583	591	599
8	408	416	424	432	440	448	456	464	472	480	488	496	504	512	520	528	536	544	552	560	568	576	584	592	600
1	601	609	617	625	633	641	649	657	665	673	681	689	697	705	713	721	729	737	745	753	761	769	777	785	793
2	602	610	618	626	634	642	650	658	666	674	682	690	698	706	714	722	730	738	746	754	762	770	778	786	794
3	603	611	619	627	635	643	651	659	667	675	683	691	699	707	715	723	731	739	747	755	763	771	779	787	795
4	604	612	620	628	636	644	652	660	668	676	684	692	700	708	716	724	732	740	748	756	764	772	780	788	796
5	605	613	621	629	637	645	653	661	669	677	685	693	701	709	717	725	733	741	749	757	765	773	781	789	797
6	606	614	622	630	638	646	654	662	670	678	686	694	702	710	718	726	734	742	750	758	766	774	782	790	798
7	607	615	623	631	639	647	655	663	671	679	687	695	703	711	719	727	735	743	751	759	767	775	783	791	799
8	608	616	624	632	640	648	656	664	672	680	688	696	704	712	720	728	736	744	752	760	768	776	784	792	800
1	801	809	817	825	833	841	849	857	865	873	881	889	897	905	913	921	929	937	945	953	961	969	977	985	993
2	802	810	818	826	834	842	850	858	866	874	882	890	898	906	914	922	930	938	946	954	962	970	978	986	994
3	803	811	819	827	835	843	851	859	867	875	883	891	899	907	915	923	931	939	947	955	963	971	979	987	995
4	804	812	820	828	836	844	852	860	868	876	884	892	900	908	916	924	932	940	948	956	964	972	980	988	996
5	805	813	821	829	837	845	853	861	869	877	885	893	901	909	917	925	933	941	949	957	965	973	981	989	997
6	806	814	822	830	838	846	854	862	870	878	886	894	902	910	918	926	934	942	950	958	966	974	982	990	998
7	807	815	823	831	839	847	855	863	871	879	887	895	903	911	919	927	935	943	951	959	967	975	983	991	999
8	808	816	824	832	840	848	856	864	872	880	888	896	904	912	920	928	936	944	952	960	968	976	984	992	1000

NOTES

RTSTM