

FMI-4 and FMI-8



PROPRIETARY NOTICE

The product information and design disclosed herein were originated by and are the property of Bosch Security Systems, Inc. Bosch reserves all patent, proprietary design, manufacturing, reproduction, use and sales rights thereto, and to any article disclosed therein, except to the extent rights are expressly granted to others.

COPYRIGHT NOTICE

Copyright 2017 by Bosch Security Systems, Inc. All rights reserved. Reproduction, in whole or in part, without prior written permission from Bosch is prohibited.

*All other trademarks are property of their respective owners.

WARRANTY AND SERVICE INFORMATION

For warranty and service information, refer to the appropriate web site below:

- RTS Intercoms www.rtsintercoms.com/warranty
- RTS Digital
- RTSTW
- AudioCom
- RadioCom
- Intercom Headsets

CUSTOMER SUPPORT

Technical questions should be directed to:



Customer Service Department
Bosch Security Systems, Inc.
www.telex.com

TECHNICAL QUESTIONS EMEA

Bosch Security Systems Technical Support EMEA
http://www.rtsintercoms.com/contact_main.php

DISCLAIMER

The manufacturer of the equipment described herein makes no expressed or implied warranty with respect to anything contained in this manual and shall not be held liable for any implied warranties of fitness for a particular application or for any indirect, special, or consequential damages. The information contained herein is subject to change without prior notice and shall not be construed as an expressed or implied commitment on the part of the manufacturer.

	CAUTION RISK OF ELECTRIC SHOCK DO NOT OPEN	
THE LIGHTNING FLASH AND ARROWHEAD WITHIN THE TRIANGLE IS A WARNING SIGN ALERTING YOU OF "DANGEROUS VOLTAGE" INSIDE THE PRODUCT.	CAUTION: TO REDUCE THE RISK OF ELECTRIC SHOCK, DO NOT REMOVE COVER. NO USER-SERVICEABLE PARTS INSIDE. REFER SERVICING TO QUALIFIED SERVICE PERSONNEL.	THE EXCLAMATION POINT WITHIN THE TRIANGLE IS A WARNING SIGN ALERTING YOU OF IMPORTANT INSTRUCTIONS ACCOMPANYING THE PRODUCT.
SEE MARKING ON BOTTOM/BACK OF PRODUCT.		

WARNING: APPARATUS SHALL NOT BE EXPOSED TO DRIPPING OR SPLASHING AND NO OBJECTS FILLED WITH LIQUIDS, SUCH AS VASES, SHALL BE PLACED ON THE APPARATUS.

WARNING: THE MAIN POWER PLUG MUST REMAIN READILY OPERABLE.

CAUTION: TO REDUCE THE RISK OF ELECTRIC SHOCK, GROUNDING OF THE CENTER PIN OF THIS PLUG MUST BE MAINTAINED.

WARNING: TO REDUCE THE RISK OF FIRE OR ELECTRIC SHOCK, DO NOT EXPOSE THIS APPARATUS TO RAIN OR MOISTURE.

WARNING: TO PREVENT INJURY, THIS APPARATUS MUST BE SECURELY ATTACHED TO THE FLOOR/WALL/RACK IN ACCORDANCE WITH THE INSTALLATION INSTRUCTIONS.

~	This product is AC only.
---	--------------------------

CE	
-----------	--

Important Safety Instructions

1. Please read this manual carefully.
2. Please keep this operating manual in a safe place.
3. Heed all warnings.
4. Follow all instructions.
5. This device may only be used in accordance to the information provided in this operating manual. Ensure that all recommendations, especially the safety recommendations as detailed in this operating manual, are followed before and during the usage of the device.
6. Do not use this device near water, for example, in humid or damp rooms.
7. Clean only with a dry cloth.
8. Do not block or cover any ventilation slits. Install the device in accordance with the operating manual.
9. Do not install or place the device near any heat source such as radiators, power-amplifiers, or any other heat producing equipment.
10. Protect the power cord from being stepped on, crushed, pinched, or damaged in any other way. Pay special attention to plugs and sockets of the device.
11. Never switch on power amplifiers before the complete system is stable and the level meters of the CONTROL software indicate a normal level.
12. Do not place this device on an unstable table, tripod, cart, etc. The device may fall, causing serious damage to the device.
13. The device can be disconnected from the power supply by pulling the plug. These must be freely accessible at all times. The should be disconnected during lightning storms or when unused for long periods of time.
14. The device must be grounded; any disconnection of the grounding is not permitted.
15. The internal components of the switched-mode power supplies operate at very high voltages. Coming into contact with them can lead to considerable electric shock, which may result in death.
16. Only use attachments specified by the manufacturer.
17. This device contains no user serviceable parts: only refer to authorized, qualified service personnel for any servicing.
18. Your warranty will be voided if you tamper with the internal components.

Owner Information

Operating Manual

Please read this manual, If you call for technical support, we assume you have already read the manual. Study the operating manual carefully in order to familiarize yourself with the device and its operation. The operating manual contains important information on proper use of the device.

It cannot be guaranteed this operating manual does not contain typographical mistakes or misprints. The operating manual is regularly revised and updated.

Modifications, which serve the purpose of technical improvement of the device, may be carried out without prior notification.

Transport and Shipping

Always ensure careful handling of the device. The device should be transported and shipped in shock-absorbing transport cases. If these are not available, we recommend well-padded packaging, such as the coated carton in which the device was delivered.

We strongly advise against the use of lightweight flight cases without shock-absorbing rack-in-rack mounting.

Operational Environment

This device can be operated in E1, E2, E3, E4 or E5 environments (as listed below) according to the harmonized European standards EN55103-1 and EN55103-2 “Electromagnetic compatibility – Product family standard for audio, video and audio-visual and entertainment lighting control apparatus for professional use”

E1 - Residential

E2 - Commercial and light industrial

E3 - Urban outdoors

E4 - Controlled EMC environment e.g. broadcast and TV-studio

E5 - Heavy industry

The product is intended for use in a moderate climate.

Ventilation

Do not block or cover any ventilation openings. Install the device in accordance with the operating manual. Allow for sufficient space around the units (at least 200mm/7.87” free space behind the rear-panel of the device) and make sure to allow for air circulation near the ventilation openings on both sides of the device. Keep the rear of the rack open during operation. Do not operate the device close to heat emitting equipment, such as power-amplifiers. Leave sufficient space (minimum 1/2 RU) between the device and any heat emitting devices housed in the same rack.

An Optocore device may be placed above or below other Optocore products, without a space between the devices for up to four adjacent rack spaces.

IMPORTANT: Do not populate more than four adjacent rack spaces with Optocore devices.
Maintain 1RU of empty space between each 4RU of Optocore devices.
Keep the equipment rack open during operation.
Ensure air circulation around the devices.
Maintain at least 200mm (~8”) clearance behind the rear panel of the devices.

Water and Moisture, etc.

To prevent fire or shock hazard, do not expose the device to direct sunlight, dust, water, or rain during operation or storage.

Cleaning

To clean the device, use a dry linen cloth. If the unit is very dirty, lightly moisten a cloth using water and a small amount of household detergent. Never use cleaning agents containing solvents to clean the device.

Power Supply

The device can be disconnected from the power supply by unplugging the power cord. The power cords must be freely accessible at all times. The device should be disconnected during lightning storms or when the device is unused for a long period of time.

IMPORTANT: The switched-mode power supplies operate at very high voltages.

Coming into contact with the power supplies can lead to considerable electric shock, which may result in death.

Never disconnect the power plug by pulling the cable. Always unplug the device.

Power-supply cords should be routed in such a way that they are not likely to be walked on, crushed, pinched, or damaged in any other way or form. Pay special attention to the AC mains sockets on the device.

IMPORTANT: A damaged power cable must be replaced immediately.

The device must be grounded. Disconnecting the ground is strictly prohibited. Ensure the device is always grounded using the power connector.

Do not cover the ground connection of the power connector with any kind of insulation material.

Fuse

There is no fuse in the device. The power supplies contain circuitry that protects the device from overload.

Lightning

For additional protection of this device during lightning storms, or when it is left unattended and unused for a long period of time, disconnect the power cord. This prevents damage to the device due to lightning and power line surges. Disconnection from the mains power supply is only possible by disconnecting the power plug from the mains socket.

Eye Safety

This product is a Laser Class 1 product. It complies with IEC 60825-1, FDA 21 CFR 1040.10, and 1040.11.

External Objects and/or Liquids

Never insert objects of any kind into the device through openings in the device chassis. The objects may come into contact with dangerous voltages or create short circuits that can result in a fire or electric shock. Never spill liquid of any kind on the device.

Cables and Accessories

Only use attachments specified by the manufacturer of the device.

Use high quality, properly terminated cables to connect the device. The device should only be used with optical fiber cables that are specified for use with the devices optical transceivers and within the specified power budget of the optical transceivers. When not in use, ensure that the optical connectors on the device and the optical fiber cables are covered with the provided caps.

Do not place this device on an unstable table, tripod, cart, etc. The device may fall, which can cause injury and serious damage to the device. Any mounting of the device should follow the manufacturers instructions, and should use mounting accessories recommended by the manufacturer of the device.

Service and Repairs

Do not attempt to service the device by yourself.

The device contains no user serviceable parts, components or controls. The operation of an opened device is not permitted. Such operation can lead to damage of the device's components due to lack of air-flow through the device.

The device may not be serviced, altered or modified without authorized distributor/dealer. Only qualified service personnel may carry out repair and maintenance work on the device. The warranty of the device will be voided if any unauthorized maintenance or repair work has been carried out.

Table of Contents

Important Safety Instructions	3
<i>Owner Information</i>	4
Operating Manual	4
Transport and Shipping	4
Operational Environment	4
Ventilation	4
Water and Moisture, etc.	5
Cleaning	5
Power Supply	5
Fuse	5
Lightning	5
Eye Safety	5
External Objects and/or Liquids	5
Cables and Accessories	6
Service and Repairs	6
<i>Device Description</i>	9
<i>Reference View</i>	10
Front Panel	10
Rear Panel	11
<i>Device Details</i>	13
Intercom Ports	13
SANE Ports	13
RS-485	13
Word Clock	13
Transmission Delay	13
Power Supply	14
<i>Control Software</i>	14
<i>Optocore Bandwidth Allocation</i>	14
<i>SANE Bandwidth Allocation</i>	14
<i>Connectors and Cables</i>	15
Intercom Ports – IC485	15
Optional Optical Connections	15

SANE Ports	15
RS232 Connection	15
Connector Hood Specification	15
USB Connection	15
LAN Connection	15
Word Clock Connection	16
Power Connection	16
<i>Hardware Connection</i>	<i>16</i>
<i>Connection Tables</i>	<i>18</i>
<i>Specifications</i>	<i>20</i>

FMI-Series

Device Description

The FMI-Series units provide AIO ports¹ with line level audio inputs and outputs, along with serial data links, via RJ-45 connectors for communication between intercom matrices and auxiliary devices. Serial control is routed with the audio, requiring audio to be routed to and from each port in order to establish bi-directional audio and serial communication between matrices and auxiliary devices.

The FMI-Series 4-wire intercom port can be used as an independently routed line level input/output using an adaptor from an RJ-45 connector to a XLR connector. The AIO ports are duplicated with reversed wiring so either matrices (TO MATRIX) or intercom keypanels (TO PANELS) can be connected to the unit using standard CAT cables which makes cabling simple and cost efficient.

The low latency, synchronous, Optocore network provides the capacity to transport and route up to 1024 audio inputs into thousands of outputs over a redundant network. Redundant fiber connections are established using the two LC multi-mode, or single-mode, 1Gbit or 2Gbit optical transceivers. The dual redundant ring topology uses the advantages of fiber optical transmission in temporary and permanent applications, especially where long distance transport and high-quality audio are required.

Additionally, the FMI-Series module includes 64 channel synchronous audio ports on CAT-5 connectors with Ethernet, four RS-485, 100 Mbit Ethernet switch and word clock input and output.

Extensive networks of FMI-Series devices can be created using devices with different connectivity options to route and transport intercom audio, serial data, and Ethernet.

Word clock input and output connectors allow the Optocore network to be synchronized from an external source as well as for the word clock to be distributed around a facility using the Optocore network. All Optocore devices are capable of being system masters using their internal clock.

The FMI-Series can be ordered with different quantities and types of inputs and outputs.

- FMI-8 - eight AIO ports with serial control (single unit)
- FMI-8 - eight AIO ports with serial control (paired unit)
- FMI-4 - four AIO ports with serial control (single unit)
- FMI-4 - four AIO ports with serial control (paired unit)

Devices and systems are configured and operated using the Control software. The software provides access to configuration parameters and controls used to operate the system, including: naming channels, setting gains, and phantom power, routing as well as recall and capture of partial or full system configurations. The software can be operated offline as well as online with level meters for all channels on the network.

IMPORTANT: Once all devices are connected in a loop, have been assigned a unique ID, and work in the same sample rate, you can manage and configure them remotely by being connected to one device via USB, LAN or RS232. For more information on assigning the Device ID, see the Control Software Manual (P/N F.01U.327.243).

1. AIO ports are commonly referred to as 4-wire intercom ports.

The FMI-4 and FMI-8 units use the latest programmable microprocessors and **FPGA** (Field Programmable Gate Array) logic circuitry. This allows the unit's firmware to be updated in the field, ensuring a continual state-of-the-art device and reduces the power usage compared to older technologies.

The LEDs on the front panel display an instant overview of the status of each channel, indicating if audio is present, if peak level is reached and if nothing is routed to an output.

Reference View

Front Panel

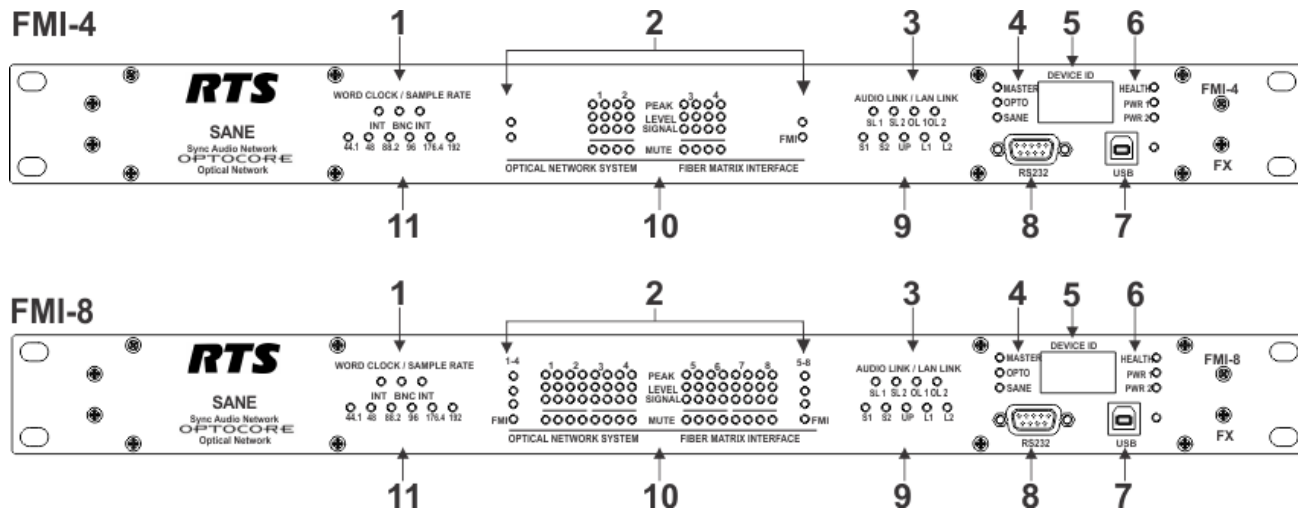

FIGURE 1. FMI-4 and FMI-8 Front Panel

1. **Word Clock LED** Indicates the selected word clock source
 - INT: Internal word clock – The device is a system master.
 - BNC: External word clock via the BNC WC input.
 - NET: Word clock received from the network.
2. **Intercom and Signal Monitor (8 and 4 duplex channels)**
 - AIO ports with bi-directional RS485 (for RTS)
 - PEAK: Red – Overflow. Input level exceeds max. input level of 0dBFS
 - LEVEL: Yellow – Warning Level. Input level exceeds -10dBFS
 - SIGNAL: Green – Signal present \geq -60dBFS. Brightness controlled.
3. **Audio Link**
 - SL1: Communication is established on the SANE^a 1 port (rear panel)
 - SL2: Communication is established on the SANE^a 2 port (rear panel)
 - OL1: Communication is established on the Optocore LINK 1 (rear panel)
 - OL2: Communication is established on the Optocore LINK 2 (rear panel)
4. **Master LED** Indicates the word clock Master unit.
OPTO LED Optocore communication is established.
SANE LED^a SANE communication is established.

-
- | | | |
|----|---|---|
| 5. | Device ID
Display | Indicates the unique identification number of the device. |
| 6. | HEALTH
LED
PWR 1 LED
PWR 2 LED | Green: Power supply to device works, temperature is below the limit.
Power supply 1 is working correctly
Power supply 2 is working correctly |
| 7. | USB plug
and LED | USB connection for remote control and update via PC
Green: Indicates data activity. |
| 8. | RS232 plug | D-Sub-9 RS232 connection for remote control and update via PC. |
| 9. | LAN LINK | S1: Ethernet communication is established via SANE 1 (rear panel)
S2: Ethernet communication is established via SANE 2 (rear panel)
UP: There is another device with a physical Ethernet port enabled on the network.
L1: Ethernet communication is established via LAN 1 (rear panel)
L2: Ethernet communication is established via LAN 2 (rear panel) |
| 10 | Mute | Red static: Output mute indicator. Nothing is routed to the output. |
| 11 | Sample Rate
LED | Yellow: 44.1/48/88.2/96/176.4/192.kHz |

-
- a. The SANE and LINE connectors can be used for Ethernet connectivity. When an Ethernet cable is connected, the LED lights when communication is established.

Rear Panel

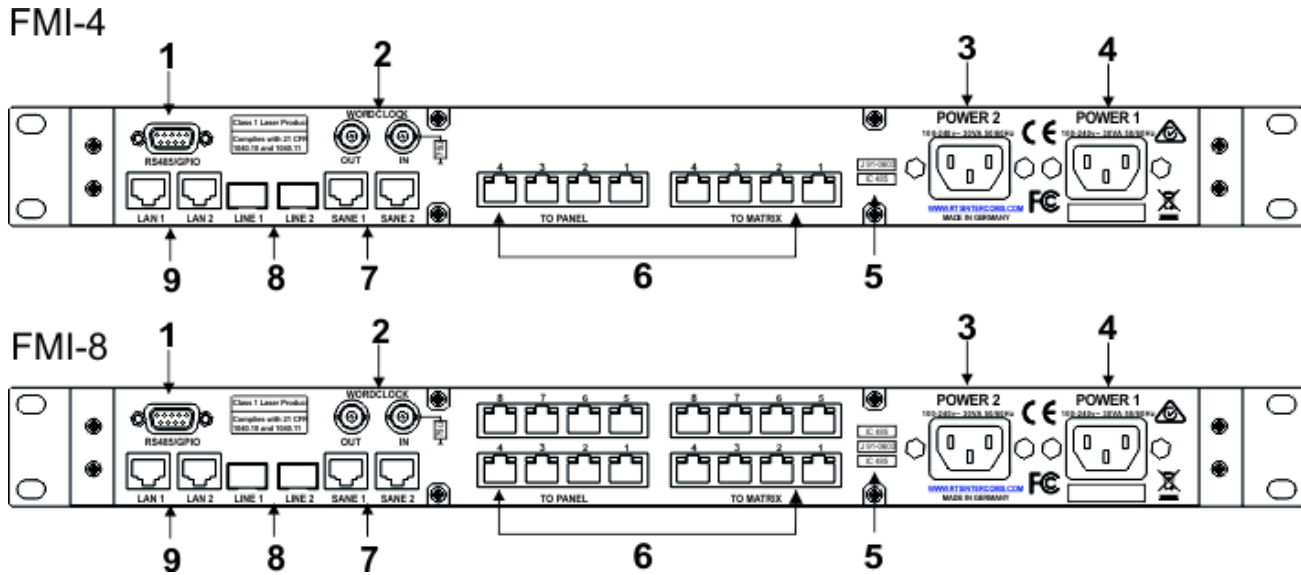

TABLE 1. FMI-Series Rear Panel

1.	RS485	4 x RS485 (D-Sub-9) auxiliary port for data transmission.
2.	Word Clock IN	BNC word clock input allowing synchronization of FMI devices/network from an external word clock source.
	Word Clock OUT	BNC word clock output for synchronization of external devices.
3.	POWER 2	Mains input for power supply 2 (100-240V)
4.	POWER 1	Mains input for power supply 1 (100-240V)
5.	Label	I/O card type in the slot(s) and serial number
6.	TO PANEL	RJ-45 AIO ports wired for connection to keypanels or interfaces (8 on FMI-8, 4 on FMI-4)
	TO MATRIX	RJ-45 AIO ports wired for connection to an intercom matrix (8 on FMI-8, 4 on FMI-4)
7.	SANE 1	SANE RJ-45 interface for audio transmission + 100 Mbit Ethernet.
	SANE 2	SANE RJ-45 interface for audio transmission + 100 Mbit Ethernet
8.	LINE 1	Full-duplex, full bandwidth LC type optical interface for Optocore transmission (SFP multimode transceiver included, single mode transceiver option available on demand).
	LINE 2	Full-duplex, full bandwidth LC type optical interface for Optocore transmission (SFP multimode transceiver included, single mode transceiver option available on demand).
9.	LAN 1	100 Mbit RJ-45 Ethernet interface
	LAN 2	100 Mbit RJ-45 Ethernet interface

Device Details

Intercom Ports

Each 4-wire intercom port is complete with a line level input, line level output and a bi-directional RS485 (device specific) serial communication link, allowing seamless integration with RTS intercom systems.

The intercom ports are duplicated with a reversed pinout (To MATRIX and TO PANEL) to allow connections to intercom matrix frames, user keypanels and interfaces using straight CAT-5 cables.

SANE Ports

SANE ports are Ethernet cable compatible allowing Ethernet connections along with the RS-485 connectors. SANE utilizes all four pairs of the CAT5 cable, two pairs for standard Ethernet transmission and two pairs for the SANE synchronous audio transport which is a MADI implementation over CAT5 cabling. A SANE cable should not exceed a total cable distance of 100 meters.

RS-485

The RS-485 auxiliary ports provide four RS-485 ports to establish a maximum of four half-duplex or two full-duplex connections between devices. A wide range of bi-directional and unidirectional standards can be connected to the ports, such as RS-485, CAN-Bus (bi-directional, requires special firmware version), and MIDI (unidirectional). The ports automatically sense whether they are sending or receiving control data.

The ports and their destinations are configured in the CONTROL software.

Word Clock

Devices with Optocore/SANE modules are equipped with an internal, high quality, low jitter clock generator as well as word clock inputs and outputs. Any device on the network can act as the master of the network and pass the word clock to networked Optocore/SANE devices. The internal/networked word clock is available at the word clock output connector of each device on the network to synchronize non-networked devices.

NOTE:

- In standalone network configurations, external synchronization is not required.
- The word clock input termination is activated using the CONTROL software's local settings. External termination is not required to avoid cable reflections.
- Word clock master negotiation after any word clock source failure is done automatically.

Transmission Delay

The Optocore system latency, including the matrix, is a fixed 41.6 μ s @ 48 kHz for all channels. The additional transport delay per FMI-Series unit on the network (<200ns) is insignificant in comparison. Overall system delay is dependent on the converters used and the length of network cables in the system. Assuming average cable lengths of <700m per link, the additional delay is considered marginal.

NOTE: The transmission delay is constant between any points in the network.

Power Supply

The device is equipped with two power inputs and power supply units. If one power supply fails, the device automatically switches over to the backup power supply unit. In order to make the power supply redundant, both power inputs must be connected to the mains supply. It is recommended to connect the power supplies to different phases, power supply systems, or even better, one of them to an uninterrupted power supply (UPS).

The power supply units operate with mains voltage of 100-240 V and frequency of 50-60Hz. Thus, the device can be used through out the world without any modifications or transformers.

WARNING: The switched mode power supplies operate at extremely high voltages. Contact with the power supplies can lead to considerable electric shock, which may result in death.

Control Software

All system and device parameters are configured using the CONTROL software.

The system can be configured and controlled centrally, over the Optocore network, with the exception of the initial configuration of the unique identifier (ID) of the device.

The CONTROL software is capable of running multiple instances on the same PC or by using the CONTROL software's client/server mode.

NOTE: See the Optocore Quick Start Guide for the basic system configuration and set up. For more detailed set up, see the Optocore Software Manual.

Optocore Bandwidth Allocation

The standard bandwidth allocation of an Optocore network:

Audio	256 Channels @ 48kHz – 1 Gbit network 768 Channels @ 48 kHz – 2 Gbit network
RS-485 Data	32 Channels
Ethernet	100 Mbit Fast Ethernet

SANE Bandwidth Allocation

The standard bandwidth allocation of an Optocore network:

Audio	64 Channels @ 48kHz
Ethernet	100 Mbit Fast Ethernet

Connectors and Cables

Intercom Ports – IC485

Use TIA/EIA-568-B standard straight-forward twisted pair cable (Cat-5, Cat-5e, Cat-6) terminated with RJ-45 connectors. Connect intercom matrix to ports labelled TO MATRIX and intercom user key-panels and interfaces to ports labeled TO PANEL.

Optional Optical Connections

Fiber connections can be purchased additionally in two different modes:

- Multi-mode* connected using a 50µm OM3 fibre cable can be used for applications requiring cable lengths of up to 300m (worst case).
- Single-mode* using a 9µm fiber cable can be used for applications requiring cable lengths of up to 70km (worst case).

TABLE 2. Cable Run Lengths Per Optical Mode

	1.0Gb	2.0Gb
Multimode		300m
Singlemode	≤10km	≤20km

The total optical loss should be less than 6dB between transceivers.

NOTE: For portable applications, such as touring and other temporary installations, ruggedized HMA Expanded Beam Connectors, mounted on 1 RU panels and portable cables on cable drums are available.

SANE Ports

Use standard, fully wired, twisted pair cable (CAT 5, CAT 5e, CAT 6) terminated with RJ-45 connectors. SANE utilizes all four pairs of the CAT 5 cable, two pairs for standard Ethernet transmission and two pairs for the SANE synchronous audio transport. A SANE cable shall not exceed a total cable distance of 100m.

IMPORTANT: SANE and Ethernet use the same cable but different pairs. Two pairs are used for audio, two pairs for Fast Ethernet - you can use full SANE (64ch @48kHz) and Ethernet bandwidth simultaneously.

RS232 Connection

Use a standard shielded RS232 cable.

Connector Hood Specification

Locking screws for D-Sub connectors should be compatible with 4-40 UNC. Care should be taken in selecting the right type of connector hoods in order to fulfil the requirements of EMI-radiation directives. Full metal connector hoods should be used, approved acc. to VDE 0871, FCC 20780 and EMC directive 2004/108/EG, providing attenuation > 40 dB between 30 MHz up to 1 GHz. The shield of the cable should have contact to the connector hood.

USB Connection

Use a USB-A to USB-B cable between the PC and the Optocore device.

LAN Connection

Use a standard twisted pair cable (Cat-5, Cat-6) with RJ-45 connectors.

Word Clock Connection

Use 75 Ω coaxial cable with BNC connectors.

Power Connection

Standard power cords with IEC C13 connectors.

Hardware Connection

Example 1 – Remote intercom keypanels, interfaces and wireless base stations. The following example demonstrates the use of FMI-Series devices with intercom matrix systems,

An FMI-8 is connected to eight 4-wire ports of a central intercom matrix. The 4-wire ports, along with RS-485 control signals (device dependent) are distributed over the fully routable Optocore redundant ring topology network to remote locations.

Intercom keypanels and various interfaces can be connected to the system at the remote locations.

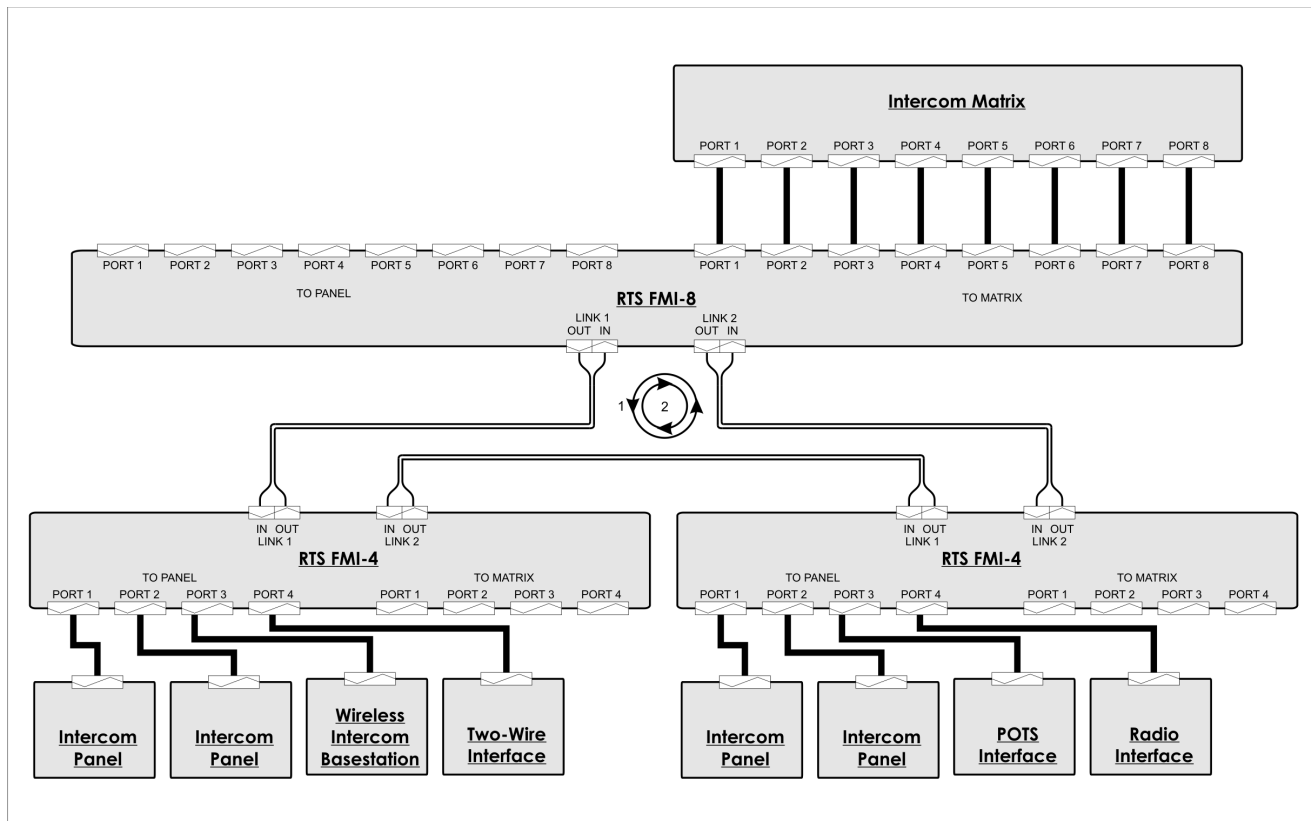

FIGURE 2. Signal distribution for intercom keypanels, interfaces, and wireless base stations

Example 2 – Trunking between Intercom Matrices. The following example demonstrates the use of FMI-Series devices to link intercom matrices.

A pair of FMI-4 devices is used to establish an eight channel trunk between two intercom matrices. The 4-wire ports are transported over a fully routable Optocore redundant ring topology network. Control for both intercom matrices are connected together using the Optocore network’s internal Ethernet switch with an optional connect to an RTS TrunkMaster TM-10K.

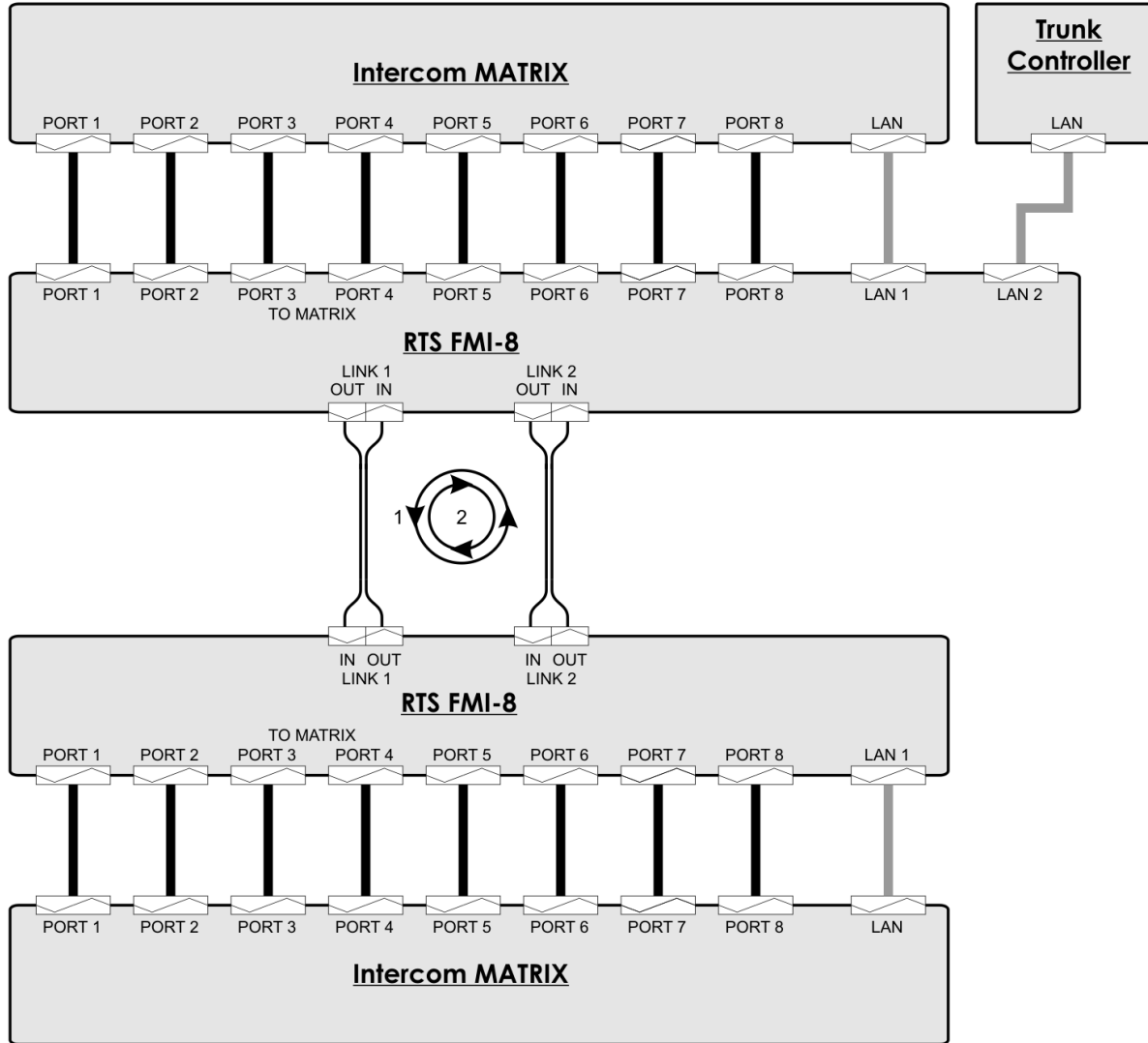

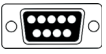



FIGURE 3. Two intercom matrices connected using Optocore intercom devices

Connection Tables

Pinout	4-Wire Intercom Port TO PANEL – RTS					
	Channel		Audio In	Audio Out	RS485 In	Use this pinout only for devices loaded with RTS *Shows the standard pinout for RS485.
	Pin	+	4	3	7	
		-	5	6	2	
RJ-45 						

Pinout	4-Wire Intercom Port TO Matrix – RTS					
	Channel		Audio In	Audio Out	RS485 In	Use this pinout only for devices loaded with RTS modules *Shows the standard pinout for RS485.
	Pin	+	3	4	7	
		-	6	5	2	
RJ-45 						

Pinout	Auxiliary Port - 4 x RS485							
			RS485				GND	Please verify the correct polarity of adaptors. Software configurable for duplex (RS485) An adaptor must be constructed for connectivity to MIDI, GPIO and CAN interfaces
			1	2	3	4		
	Pin	+	1	2	3	4	5	
		-	6	7	8	9		
	D-Sub-9-female							Locking system 4-40 acc to 4-40 UNC

Pinout		SANE - Synchronous Audio and Ethernet					A device compatible with 10/100MB Fast Ethernet can be connected to a SANE port for Ethernet data communication
			SANE/ MADI In	SANE / MADI Out	Ethernet In	Ethernet Out	
	Pin	+	7	4	3	1	
		-	8	5	6	2	
RJ-45 							

Pinout		Optical Fiber Port	
		Optocore	
		RXD	TXD
	Pin	1	2
LC Connectors 			

Pinout		RS232 - Port					Use standard RS232 cable male - female, to connect to PC	
	Channel	RS232		Internally Bridged		Power		
	Pin	RXD	TXD	1, 4, 6	7, 8	+5VS		GND
		3	2			9	5	
		D-Sub 9 Female					Locking system acc. to 4-40 UNC	

Pinout		USB Port				
	Channel	USB			GND	USB-B device connector
		VBUS	D-	D+		
	Pin	1	2	3	4	
						

Pinout	DC Input - Factory Fitted Option			
	Pin	+	12V	Gnd
			4	1
XLR-4 Pin Male				
				

Specifications

INTERCOM ports Hardware standard:

Hardware Standard

FCC-RJ45
(8 outputs, 8 inputs or 4 outputs, 4 inputs)

Analog Line Input

Impedance
10K Ω
Maximum input level
+18dBu
SNR
115dB (A-weighted)
THD+N @ -1dBFS
 ≥ 100 dB

Analog Line Output

Impedance
45K Ω
Maximum input level
+18dBu
SNR
115dB (A-weighted)
THD+N @ -1dBFS
 ≥ 98 dB

Serial I/O

EIA/TIA-485

SANE, LAN Ports Convention

Audio

TIA-568A/B, Optocore
200 Mbits/s

LAN

TIA-568A/B, IEEE-802.3
10/100 Mbits/s

Auxiliary Ports Convention EIA/TIA-485

Data Channels

Digital Control Data
4
Data Rate
Up to 10Mbps

Impedance

Termination
330 Ω
Source
 $\leq 10 \Omega$

Word Clock Hardware Standard 75 Ω /BNC

Data Rate

depending on sample rate used
44.1/48/88.2/96/176.4/192kHz

Impedance

Output
75 Ω
Input
1k/75 Ω software switch

Optical Link Input, Output, Dual - Full Bandwidth

Connection
Duplex LC
Protocol
Optocore
Transmission
Full Duplex
Data Rate
2x2 Gbps
Latency
41.6 μ s fixed

Optical Wave Guide Cable Lengths

Multimode Fiber

$50\mu\text{m} \leq 300\text{m}$

Single mode Fiber

$9\mu\text{m} \leq 10\text{km @ 2GB}$

$9\mu\text{m} \leq 20\text{km @ 1GB}$

Word Clock Hardware Standard 75Ω/BNC

Data Rate

44.1kHz – 192kHz

Power Supply 2 (optional) - independent power supplies with function check and automatic switch-over

Type

Switch-mode, universal input

Mains Voltage

100...200VAC, 50/60Hz, 25VA-typ., 32VA-peak

Remote Control

RS232/USB/Ethernet Control Interface to PC

Dimensions

19.0" W x 1.73" H x 7.87" D (483mm W x 44mm H x 200mm D)

Weight

6lbs (2.7kg)

Bosch Security Systems, Inc.
12000 Portland Avenue South
Burnsville, MN 55337 U.S.A.
www.boschcommunications.com